

MKS Baratron®
Type 627F
Absolute Pressure Transducer

Copyright © 2013 by MKS Instruments, Inc.

All rights reserved. No part of this work may be reproduced or transmitted in any form or by any means, electronic or mechanical, including photocopying and recording, or by any information storage or retrieval system, except as may be expressly permitted in writing by MKS Instruments, Inc.

Printed in the United States of America

mksinst[™] is a trademark and Baratron[®] is a registered trademark of MKS Instruments, Inc., Andover, MA, USA.

Swagelok[®], VCO[®], and VCR[®] are registered trademarks of Swagelok Co., Solon, OH, USA

Inconel[®] and Incoloy[®] are registered trademarks of Inco Alloys International, Inc., Huntington, WV, USA.

Some Baratron[®] products may not be exported to many end user countries without both US and local government export licenses under ECCN 2B230.

Table of Contents

Pressure Transducer Safety Information.....	1
Symbols Used in This Instruction Manual.....	1
Symbols Found on the Unit	2
Safety Procedures and Precautions	3
Sicherheitshinweise für den Druckmeßumformer	5
In dieser Betriebsanleitung vorkommende Symbole	5
Erklärung der am Gerät angebrachten Symbole	6
Sicherheitsvorschriften und Vorsichtsmaßnahmen.....	7
Informations relatives à la sécurité pour le transducteur de pression	9
Symboles utilisés dans ce manuel d'utilisation	9
Symboles apparaissant sur l'unité	10
Mesures de sécurité et précautions	11
Medidas de seguridad del transductor de presión	13
Símbolos usados en este manual de instrucciones	13
Símbolos hallados en la unidad.....	14
Procedimientos y precauciones de seguridad.....	15
Chapter One: General Information	17
Introduction.....	17
How This Manual is Organized	18
Customer Support	18
Chapter Two: Installation	19
How To Unpack the Type 627F Unit	19
Unpacking Checklist.....	19
Interface Cables	20
Generic Shielded Cable Guidelines	21
Product Location and Requirements.....	22
Ambient Operating Temperature	22
Power Requirements	22
Setup	23

Dimensions	23
Fittings	24
Mounting Instructions	24
Electrical Information	25
Grounding	25
Interface Connector.....	26
Start Up	28
Warm Up Time	28
Chapter Three: Overview.....	29
General Information.....	29
Sensor.....	29
Signal Conditioner/Electronics	29
Instrument Components	30
Coarse Zero Switch.....	30
Optional Heater Status LEDs and Semiconductor Switches	30
Zero Potentiometer	30
Interface Connector.....	30
Labels.....	31
Top Panel Labels	31
Band Label.....	31
Serial Number Label	32
Chapter Four: Operation	33
How To Adjust the Zero	33
How To Adjust the Zero Potentiometer.....	34
How To Adjust the Coarse Zero Switch.....	35
Suggested Pressures for Reading and Control	36
Chapter Five: Maintenance and Troubleshooting.....	37
General Information.....	37
Maintenance.....	37
Zero Adjustment	37
Troubleshooting.....	38
Appendix A: Product Specifications.....	39

Electrical Specifications	39
Environmental Specifications	39
Performance Specifications	39
Physical Specifications	40
Optional Semiconductor Switch Specifications.....	40
Appendix B: Model Code Explanation.....	41
Model Code.....	41
Index	43

List of Figures and Tables

Figures

Figure 1: Top View Dimensions	23
Figure 2: Side View Dimensions	23
Figure 3: Example Power, Signal, and Chassis Grounding Scheme.....	25
Figure 4: Top View of the 627F Transducer.....	30
Figure 5: Top Panel Label for Units without the Optional Heater Status LEDs.....	31
Figure 6: Top Panel Label for Units with the Optional Heater Status LEDs.....	31
Figure 7: Band Label	31
Figure 8: Serial Number Label	32

Tables

Table 1: Definition of Symbols Found on the Unit	2
Tabelle 2: Bedeutung der am Gerät angebrachten Symbole.....	6
Tableau 3: Définition des symboles apparaissant sur l'unité	10
Tabla 4: Definición de los símbolos hallados en la unidad.....	14
Table 5: Interface Cables	20
Table 6: Interface Connector Pinout.....	27
Table 7: Highest Pressures Suggested for Proper Zero Adjustment.....	34
Table 8: Lowest Suggested Pressures for Reading and Control	36
Table 9: Troubleshooting Chart.....	38

Pressure Transducer Safety Information

Symbols Used in This Instruction Manual

Definitions of WARNING, CAUTION, and NOTE messages used throughout the manual.

Warning  The **WARNING** sign denotes a hazard to personnel. It calls attention to a procedure, practice, condition, or the like, which, if not correctly performed or adhered to, could result in injury to personnel.

Caution  The **CAUTION** sign denotes a hazard to equipment. It calls attention to an operating procedure, practice, or the like, which, if not correctly performed or adhered to, could result in damage to or destruction of all or part of the product.

Note  The **NOTE** sign denotes important information. It calls attention to a procedure, practice, condition, or the like, which is essential to highlight.

Symbols Found on the Unit

The following table describes symbols that may be found on the unit.



















Definition of Symbols Found on the Unit			
  Off (Supply) IEC 417, No.5008	 Off (Supply) IEC 417, No.5008	  Protective earth (ground) IEC 417, No.5019	 Protective earth (ground) IEC 417, No.5019
  Direct current IEC 417, No.5021	 Direct current IEC 417, No.5021	  Alternating current IEC 417, No.5032	 Alternating current IEC 417, No.5032
 Both direct and alternating current IEC 417, No.5033-a	  Three phase alternating current IEC 617-2 No.020206	 Three phase alternating current IEC 617-2 No.020206	
 Caution, refer to accompanying documents ISO 3864, No.B.3.1	 Caution, risk of electric shock ISO 3864, No.B.3.6	 Caution, hot surface IEC 417, No.5041	

Table 1: Definition of Symbols Found on the Unit

Safety Procedures and Precautions

Observe the following general safety precautions during all phases of operation of this instrument. Failure to comply with these precautions or with specific warnings elsewhere in this manual violates safety standards of intended use of the instrument and may impair the protection provided by the equipment. MKS Instruments, Inc. assumes no liability for the customer's failure to comply with these requirements.

DO NOT SUBSTITUTE PARTS OR MODIFY INSTRUMENT

Do not install substitute parts or perform any unauthorized modification to the instrument. Return the instrument to an MKS Calibration and Service Center for service and repair to ensure that all safety features are maintained.

SERVICE BY QUALIFIED PERSONNEL ONLY

Operating personnel must not attempt component replacement and internal adjustments. Any service must be made by qualified service personnel only.

USE CAUTION WHEN OPERATING WITH HAZARDOUS MATERIALS

If hazardous materials are used, users must take responsibility to observe the proper safety precautions, completely purge the instrument when necessary, and ensure that the material used is compatible with the materials in this product, including any sealing materials.

PURGE THE INSTRUMENT

After installing the unit, or before removing it from a system, purge the unit completely with a clean, dry gas to eliminate all traces of the previously used flow material.

USE PROPER PROCEDURES WHEN PURGING

This instrument must be purged under a ventilation hood, and gloves must be worn for protection.

DO NOT OPERATE IN AN EXPLOSIVE ENVIRONMENT

To avoid explosion, do not operate this product in an explosive environment unless it has been specifically certified for such operation.

USE PROPER FITTINGS AND TIGHTENING PROCEDURES

All instrument fittings must be consistent with instrument specifications, and compatible with the intended use of the instrument. Assemble and tighten fittings according to manufacturer's directions.

CHECK FOR LEAK-TIGHT FITTINGS

Carefully check all vacuum component connections to ensure leak-tight installation.

OPERATE AT SAFE INLET PRESSURES

Never operate at pressures higher than the rated maximum pressure (refer to the product specifications for the maximum allowable pressure).

INSTALL A SUITABLE BURST DISC

When operating from a pressurized gas source, install a suitable burst disc in the vacuum system to prevent system explosion should the system pressure rise.

KEEP THE UNIT FREE OF CONTAMINANTS

Do not allow contaminants to enter the unit before or during use. Contamination such as dust, dirt, lint, glass chips, and metal chips may permanently damage the unit or contaminate the process.

ALLOW PROPER WARM UP TIME FOR TEMPERATURE-CONTROLLED UNITS

Temperature-controlled units will only meet specifications when sufficient time is allowed for the unit to meet, and stabilize at, the designed operating temperature. Do not zero or calibrate the unit until the warm up is complete.

Sicherheitshinweise für den Druckmeßumformer

In dieser Betriebsanleitung vorkommende Symbole

Bedeutung der mit WARNUNG!, VORSICHT! und HINWEIS gekennzeichneten Absätze in dieser Betriebsanleitung.

Warnung!



Das Symbol **WARNUNG!** weist auf eine Gefahr für das Bedienpersonal hin. Es macht auf einen Arbeitsablauf, eine Arbeitsweise, einen Zustand oder eine sonstige Gegebenheit aufmerksam, deren unsachgemäße Ausführung bzw. ungenügende Berücksichtigung zu Verletzungen führen kann.

Vorsicht!



Das Symbol **VORSICHT!** weist auf eine Gefahr für das Gerät hin. Es macht auf einen Bedienungsablauf, eine Arbeitsweise oder eine sonstige Gegebenheit aufmerksam, deren unsachgemäße Ausführung bzw. ungenügende Berücksichtigung zu einer Beschädigung oder Zerstörung des Gerätes oder von Teilen des Gerätes führen kann.

Hinweis



Das Symbol **HINWEIS** macht auf wichtige Informationen bezüglich eines Arbeitsablaufs, einer Arbeitsweise, eines Zustands oder einer sonstige Gegebenheit aufmerksam.

Erklärung der am Gerät angebrachten Symbole

Nachstehender Tabelle sind die Bedeutungen der Symbole zu entnehmen, die am Gerät angebracht sein können.















Bedeutung der am Gerät angebrachten Symbole			
			
Ein (Energie) IEC 417, No.5007	Aus (Energie) IEC 417, No.5008	Erdanschluß IEC 417, No.5017	Schutzleiteranschluß IEC 417, No.5019
			
Masseanschluß IEC 417, No.5020	Aquipotential- anschluß IEC 417, No.5021	Gleichstrom IEC 417, No.5031	Wechselstrom IEC 417, No.5032
			
Gleich- oder Wechselstrom IEC 417, No.5033-a	Durchgängige doppelte oder verstärkte Isolierung IEC 417, No.5172-a	Dreileiter- Wechselstrom (Drehstrom) IEC 617-2, No.020206	
			
Warnung vor einer Gefahrenstelle (Achtung, Dokumen- tation beachten) ISO 3864, No.B.3.1	Warnung vor gefährlicher elektrischer Spannung ISO 3864, No.B.3.6	Höhere Temperatur an leicht zugänglichen Teilen IEC 417, No.5041	

Tabelle 2: Bedeutung der am Gerät angebrachten Symbole

Sicherheitsvorschriften und Vorsichtsmaßnahmen

Folgende allgemeine Sicherheitsvorschriften sind während allen Betriebsphasen dieses Gerätes zu befolgen. Eine Mißachtung der Sicherheitsvorschriften und sonstiger Warnhinweise in dieser Betriebsanleitung verletzt die für dieses Gerät und seine Bedienung geltenden Sicherheitsstandards, und kann die Schutzvorrichtungen an diesem Gerät wirkungslos machen. MKS Instruments, Inc. haftet nicht für Mißachtung dieser Sicherheitsvorschriften seitens des Kunden.

Niemals Teile austauschen oder Änderungen am Gerät vornehmen!

Ersetzen Sie keine Teile mit baugleichen oder ähnlichen Teilen, und nehmen Sie keine eigenmächtigen Änderungen am Gerät vor. Schicken Sie das Gerät zwecks Wartung und Reparatur an den MKS-Kalibrierungs- und -Kundendienst ein. Nur so wird sichergestellt, daß alle Schutzvorrichtungen voll funktionsfähig bleiben.

Wartung nur durch qualifizierte Fachleute!

Das Auswechseln von Komponenten und das Vornehmen von internen Einstellungen darf nur von qualifizierten Fachleuten durchgeführt werden, niemals vom Bedienpersonal.

Vorsicht beim Arbeiten mit gefährlichen Stoffen!

Wenn gefährliche Stoffe verwendet werden, muß der Bediener die entsprechenden Sicherheitsvorschriften genauestens einhalten, das Gerät, falls erforderlich, vollständig spülen, sowie sicherstellen, daß der Gefahrstoff die am Gerät verwendeten Materialien, insbesondere Dichtungen, nicht angreift.

Spülen des Gerätes mit Gas!

Nach dem Installieren oder vor dem Ausbau aus einem System muß das Gerät unter Einsatz eines reinen Trockengases vollständig gespült werden, um alle Rückstände des Vorgängermediums zu entfernen.

Anweisungen zum Spülen des Gerätes

Das Gerät darf nur unter einer Ablufthaube gespült werden. Schutzhandschuhe sind zu tragen.

Gerät nicht zusammen mit explosiven Stoffen, Gasen oder Dämpfen benutzen!

Um der Gefahr einer Explosion vorzubeugen, darf dieses Gerät niemals zusammen mit (oder in der Nähe von) explosiven Stoffen aller Art eingesetzt werden, sofern es nicht ausdrücklich für diesen Zweck zugelassen ist.

Anweisungen zum Installieren der Armaturen!

Alle Anschlußstücke und Armaturenteile müssen mit der Gerätespezifikation übereinstimmen, und mit dem geplanten Einsatz des Gerätes kompatibel sein. Der Einbau, insbesondere das Anziehen und Abdichten, muß gemäß den Anweisungen des Herstellers vorgenommen werden.

Verbindungen auf Undichtigkeiten prüfen!

Überprüfen Sie sorgfältig alle Verbindungen der Vakuumkomponenten auf undichte Stellen.

Gerät nur unter zulässigen Anschlußdrücken betreiben!

Betreiben Sie das Gerät niemals unter Drücken, die den maximal zulässigen Druck (siehe Produktspezifikationen) übersteigen.

Geeignete Berstscheibe installieren!

Wenn mit einer unter Druck stehenden Gasquelle gearbeitet wird, sollte eine geeignete Berstscheibe in das Vakuumsystem installiert werden, um eine Explosionsgefahr aufgrund von steigendem Systemdruck zu vermeiden.

Verunreinigungen im Gerät vermeiden!

Stellen Sie sicher, daß Verunreinigungen jeglicher Art weder vor dem Einsatz noch während des Betriebs in das Instrumenteninnere gelangen können. Staub- und Schmutzpartikel, Glassplitter oder Metallspäne können das Gerät dauerhaft beschädigen oder Prozeß und Meßwerte verfälschen.

Bei Geräten mit Temperaturkontrolle korrekte Anwärmzeit einhalten!

Temperaturkontrollierte Geräte arbeiten nur dann gemäß ihrer Spezifikation, wenn genügend Zeit zum Erreichen und Stabilisieren der Betriebstemperatur eingeräumt wird. Kalibrierungen und Nulleinstellungen sollten daher nur nach Abschluß des Anwärmvorgangs durchgeführt werden.

Informations relatives à la sécurité pour le transducteur de pression

Symboles utilisés dans ce manuel d'utilisation

Définitions des indications AVERTISSEMENT, ATTENTION, et REMARQUE utilisées dans ce manuel.

Avertissement



L'indication **AVERTISSEMENT** signale un danger pour le personnel. Elle attire l'attention sur une procédure, une pratique, une condition, ou toute autre situation présentant un risque d'accident pour le personnel, en cas d'exécution incorrecte ou de non respect des consignes.

Attention



L'indication **ATTENTION** signale un danger pour l'appareil. Elle attire l'attention sur une procédure d'exploitation, une pratique, ou toute autre situation, présentant un risque d'endommagement ou de destruction d'une partie ou de la totalité de l'appareil, en cas d'exécution incorrecte ou de non respect des consignes.

Remarque



L'indication **REMARQUE** signale une information importante. Elle attire l'attention sur une procédure, une pratique, une condition, ou toute autre situation, présentant un intérêt particulier.

Symboles apparaissant sur l'unité

Le tableau suivant décrit les symboles pouvant apparaître sur l'unité.















Définition des symboles apparaissant sur l'unité			
			
Marche (sous tension) IEC 417, No.5007	Arrêt (hors tension) IEC 417, No.5008	Terre (masse) IEC 417, No.5017	Terre de protection (masse) IEC 417, No.5019
			
Masse IEC 417, No.5020	Equipotentialité IEC 417, No.5021	Courant continu IEC 417, No.5031	Courant alternatif IEC 417, No.5032
			
Courant continu et alternatif IEC 417, No.5033-a	Matériel de classe II IEC 417, No.5172-a	Courant alternatif triphasé IEC 617-2, No.020206	
			
Attention : se reporter à la documentation ISO 3864, No.B.3.1	Attention : risque de choc électrique ISO 3864, No.B.3.6	Attention : surface brûlante IEC 417, No.5041	

Tableau 3: Définition des symboles apparaissant sur l'unité

Mesures de sécurité et précautions

Prendre les précautions générales de sécurité suivantes pendant toutes les phases d'exploitation de cet appareil. Le non respect de ces précautions ou des avertissements contenus dans ce manuel constitue une violation des normes de sécurité relatives à l'utilisation de l'appareil et peut diminuer la protection fournie par l'appareil. MKS Instruments, Inc. n'assume aucune responsabilité concernant le non respect des consignes par les clients.

PAS DE SUBSTITUTION DE PIÈCES OU DE MODIFICATION DE L'APPAREIL

Ne pas installer des pièces de substitution ou effectuer des modifications non autorisées sur l'appareil. Renvoyer l'appareil à un centre de service et de calibrage MKS pour tout dépannage ou réparation afin de garantir l'intégrité des dispositifs de sécurité.

DÉPANNAGE UNIQUEMENT PAR DU PERSONNEL QUALIFIÉ

Le personnel d'exploitation ne doit pas essayer de remplacer des composants ou de faire des réglages internes. Tout dépannage doit être uniquement effectué par du personnel qualifié.

PRÉCAUTION EN CAS D'UTILISATION AVEC DES PRODUITS DANGEREUX

Si des produits dangereux sont utilisés, l'utilisateur est responsable de la prise des mesures de précaution appropriées, de la purge complète de l'appareil quand cela est nécessaire, et de la garantie que les produits utilisés sont compatibles avec les composants de cet appareil, y compris les matériaux d'étanchéité.

PURGE DE L'APPAREIL

Après l'installation de l'unité, ou avant son enlèvement d'un système, purger l'unité complètement avec un gaz propre et sec afin d'éliminer toute trace du produit de flux utilisé précédemment.

UTILISATION DES PROCÉDURES APPROPRIÉES POUR LA PURGE

Cet appareil doit être purgé sous une hotte de ventilation, et il faut porter des gants de protection.

PAS D'EXPLOITATION DANS UN ENVIRONNEMENT EXPLOSIF

Pour éviter toute explosion, ne pas utiliser cet appareil dans un environnement explosif, sauf en cas d'homologation spécifique pour une telle exploitation.

UTILISATION D'ÉQUIPEMENTS APPROPRIÉS ET PROCÉDURES DE SERRAGE

Tous les équipements de l'appareil doivent être cohérents avec ses spécifications, et compatibles avec l'utilisation prévue de l'appareil. Assembler et serrer les équipements conformément aux directives du fabricant.

VÉRIFICATION DE L'ÉTANCHÉITÉ DES CONNEXIONS

Vérifier attentivement toutes les connexions des composants pour le vide afin de garantir l'étanchéité de l'installation.

EXPLOITATION AVEC DES PRESSIONS D'ENTRÉE NON DANGEREUSES

Ne jamais utiliser des pressions supérieures à la pression nominale maximum (se reporter aux spécifications de l'unité pour la pression maximum admissible).

INSTALLATION D'UN DISQUE D'ÉCHAPPEMENT ADAPTÉ

En cas d'exploitation avec une source de gaz pressurisé, installer un disque d'échappement adapté dans le système à vide, afin d'éviter une explosion du système en cas d'augmentation de la pression.

MAINTIEN DE L'UNITÉ À L'ABRI DES CONTAMINATIONS

Ne pas laisser des produits contaminants pénétrer dans l'unité avant ou pendant l'utilisation. Des produits contaminants tels que des poussières et des fragments de tissu, de glace et de métal peuvent endommager l'unité d'une manière permanente ou contaminer le processus.



RESPECT DU TEMPS D'ÉCHAUFFEMENT APPROPRIÉ POUR LES UNITÉS À TEMPÉRATURE CONTRÔLÉE

Les unités à température contrôlée atteignent leurs spécifications uniquement quand on leur laisse un temps suffisant pour atteindre d'une manière stable la température d'exploitation. Ne pas remettre à zéro ou calibrer l'unité tant que l'échauffement n'est pas terminé.

Medidas de seguridad del transductor de presión

Símbolos usados en este manual de instrucciones

Definiciones de los mensajes de advertencia, precaución y de las notas usados en el manual.

Advertencia		El símbolo de advertencia indica la posibilidad de que se produzcan daños personales. Pone de relieve un procedimiento, práctica, estado, etc. que en caso de no realizarse u observarse correctamente puede causar daños personales.
Precaución		El símbolo de precaución indica la posibilidad de producir daños al equipo. Pone de relieve un procedimiento operativo, práctica, estado, etc. que en caso de no realizarse u observarse correctamente puede causar daños o la destrucción total o parcial del equipo.
Nota		El símbolo de notas indica información de importancia. Este símbolo pone de relieve un procedimiento, práctica o condición cuyo conocimiento es esencial destacar.

Símbolos hallados en la unidad

La tabla siguiente contiene los símbolos que puede hallar en la unidad.















Definición de los símbolos hallados en la unidad			
			
Encendido (alimentación eléctrica) IEC 417, N° 5007	Apagado (alimentación eléctrica) IEC 417, N° 5008	Puesta a tierra IEC 417, N° 5017	Protección a tierra IEC 417, N° 5019
			
Caja o chasis IEC 417, N° 5020	Equipotencialidad IEC 417, N° 5021	Corriente continua IEC 417, N° 5031	Corriente alterna IEC 417, N° 5032
			
Corriente continua y alterna IEC 417, N° 5033-a	Equipo de clase II IEC 417, N° 5172-a	Corriente alterna trifásica IEC 617-2, N° 020206	
			
Precaución. Consulte los documentos adjuntos ISO 3864, N° B.3.1	Precaución. Riesgo de descarga eléctrica ISO 3864, N° B.3.6	Precaución. Superficie caliente IEC 417, N° 5041	

Tabla 4: Definición de los símbolos hallados en la unidad

Procedimientos y precauciones de seguridad

Las precauciones generales de seguridad descritas a continuación deben observarse durante todas las etapas de funcionamiento del instrumento. La falta de cumplimiento de dichas precauciones o de las advertencias específicas a las que se hace referencia en el manual, constituye una violación de las normas de seguridad establecidas para el uso previsto del instrumento y podría anular la protección proporcionada por el equipo. Si el cliente no cumple dichas precauciones y advertencias, MKS Instruments, Inc. no asume responsabilidad legal alguna.

NO UTILICE PIEZAS NO ORIGINALES O MODIFIQUE EL INSTRUMENTO

No instale piezas que no sean originales ni modifique el instrumento sin autorización. Para asegurar el correcto funcionamiento de todos los dispositivos de seguridad, envíe el instrumento al Centro de servicio y calibración de MKS toda vez que sea necesario repararlo o efectuar tareas de mantenimiento.

LAS REPARACIONES DEBEN SER EFECTUADAS ÚNICAMENTE POR TÉCNICOS AUTORIZADOS

Los operarios no deben intentar reemplazar los componentes o realizar tareas de ajuste en el interior del instrumento. Las tareas de mantenimiento o reparación deben ser realizadas únicamente por personal autorizado.

TENGA CUIDADO CUANDO TRABAJE CON MATERIALES TÓXICOS

Cuando se utilicen materiales tóxicos, es responsabilidad de los operarios tomar las medidas de seguridad correspondientes, purgar totalmente el instrumento cuando sea necesario y comprobar que el material utilizado sea compatible con los materiales del instrumento e inclusive, con todos los materiales de sellado.

PURGUE EL INSTRUMENTO

Una vez instalada la unidad o antes de retirarla del sistema, purgue completamente la unidad con gas limpio y seco para eliminar todo resto de la sustancia líquida empleada anteriormente.

USE PROCEDIMIENTOS ADECUADOS PARA REALIZAR LA PURGA

El instrumento debe purgarse debajo de una campana de ventilación y deben utilizarse guantes protectores.

NO HAGA FUNCIONAR EL INSTRUMENTO EN AMBIENTES CON RIESGO DE EXPLOSIÓN

Para evitar que se produzcan explosiones, no haga funcionar este instrumento en un ambiente con riesgo de explosiones, excepto cuando el mismo haya sido certificado específicamente para tal uso.

USE ACCESORIOS ADECUADOS Y REALICE CORRECTAMENTE LOS PROCEDIMIENTOS DE AJUSTE

Todos los accesorios del instrumento deben cumplir las especificaciones del mismo y ser compatibles con el uso que se debe dar al instrumento. Arme y ajuste los accesorios de acuerdo con las instrucciones del fabricante.

COMPRUEBE QUE LAS CONEXIONES SEAN A PRUEBA DE FUGAS

Inspeccione cuidadosamente las conexiones de los componentes de vacío para comprobar que hayan sido instalados a prueba de fugas.

HAGA FUNCIONAR EL INSTRUMENTO CON PRESIONES DE ENTRADA SEGURAS

No haga funcionar nunca el instrumento con presiones superiores a la máxima presión nominal (en las especificaciones del instrumento hallará la presión máxima permitida).

INSTALE UNA CÁPSULA DE SEGURIDAD ADECUADA

Cuando el instrumento funcione con una fuente de gas presurizado, instale una cápsula de seguridad adecuada en el sistema de vacío para evitar que se produzcan explosiones cuando suba la presión del sistema.

MANTENGA LA UNIDAD LIBRE DE CONTAMINANTES

No permita el ingreso de contaminantes en la unidad antes o durante su uso. Los productos contaminantes tales como polvo, suciedad, pelusa, lascas de vidrio o virutas de metal pueden dañar irreparablemente la unidad o contaminar el proceso.

CALIENTE ADECUADAMENTE LAS UNIDADES CONTROLADAS POR MEDIO DE TEMPERATURA

Las unidades controladas por medio de temperatura funcionarán de acuerdo con las especificaciones sólo cuando se las caliente durante el tiempo suficiente para permitir que lleguen y se estabilicen a la temperatura de operación indicada. No calibre la unidad y no la ponga en cero hasta que finalice el procedimiento de calentamiento.

Chapter One: General Information

Introduction

Note

Some Baratron[®] products may not be exported to many end user countries without both US and local government export licenses under ECCN 2B230.

The MKS Baratron[®] Type 627F Absolute Pressure Transducer is part of the MKS family of general purpose RoHS (Restriction of Hazardous Substances)-compliant pressure transducers designed to provide accurate, reliable, and repeatable pressure measurements in the range from 1K Torr to as low as 0.02 Torr Full Scale (FS). The instrument operates with ± 15 VDC ($\pm 5\%$) input at ≤ 250 mA, and provides 0 to 10 VDC output linear with pressure. The 627F transducer exposes only Inconel[®] to the process permitting use with corrosive or dirty gases and eliminating contamination of the process with transducer materials. Measurements are independent of gas composition and the unit has a minimum measuring range of four decades.

Using the latest single-sided, dual-electrode Inconel transducer design, coupled with a low impedance, fixed-frequency bridge signal conditioner, these instruments are capable of withstanding high overpressure conditions (45 psia) with minimal or no shifts in output over their range. The advanced bridge signal conditioning technology provides high accuracy and operation which is extremely temperature-stable at operating pressure.

Protection from RF interference and noisy electrical environments is increased by the use of a metal case, by internal design elements, and by the use of surge and ESD suppression networks and RFI filtering on all inputs and outputs. The 627F unit meets the testing standards required for the European CE Mark when used with an overall metal braided shielded cable, properly grounded at both ends.

The 627F transducer is designed specifically to meet the needs of vacuum process systems where environmental and process conditions are particularly demanding. The 627F unit controls its temperature at 45° C (113° F), thereby minimizing the effects of ambient or process temperature variations typically encountered in process line environments.

The 627F transducer is available with optional heater status LEDs, two interface connector lock options, and a variety of fittings. The unit is capable of measuring pressure at ambient temperatures of 15° to 40° C (59° to 104° F).

How This Manual is Organized

This manual is designed to provide instructions on how to set up, install, and operate a Type 627F unit.

Before installing your Type 627F unit in a system and/or operating it, carefully read and familiarize yourself with all precautionary notes in the *Safety Messages and Procedures* section at the front of this manual. In addition, observe and obey all WARNING and CAUTION notes provided throughout the manual.

Chapter One, *General Information*, (this chapter) introduces the product and describes the organization of the manual.

Chapter Two, *Installation*, explains the environmental requirements and describes how to mount the instrument in your system.

Chapter Three, *Overview*, gives a brief description of the instrument and its functionality.

Chapter Four, *Operation*, describes how to use the instrument and explains all the functions and features.

Chapter Five, *Maintenance and Troubleshooting*, lists any maintenance required to keep the instrument in good working condition, and provides a checklist for reference should the instrument malfunction.

Appendix A, *Product Specifications*, lists the specifications of the instrument.

Appendix B, *Model Code Explanation*, describes the model code used to order the instrument.

Customer Support

Standard maintenance and repair services are available at all of our regional MKS Calibration and Service Centers, listed on the back cover. In addition, MKS accepts the instruments of other manufacturers for recalibration using the Primary and Transfer Standard calibration equipment located at all of our regional service centers. Should any difficulties arise in the use of your Type 627F instrument, or to obtain information about companion products MKS offers, contact any authorized MKS Calibration and Service Center. If it is necessary to return the instrument to MKS, please obtain an RMA (Return Materials Authorization) Number from the MKS Calibration and Service Center before shipping. The RMA Number expedites handling and ensures proper servicing of your instrument.

Please refer to the inside of the back cover of this manual for a list of MKS Calibration and Service Centers.

Warning



All returns to MKS Instruments must be free of harmful, corrosive, radioactive, or toxic materials.

Chapter Two: Installation

How To Unpack the Type 627F Unit

MKS has carefully packed the Type 627F unit so that it will reach you in perfect operating order. Upon receiving the unit, however, you should check for defects, cracks, broken connectors, etc., to be certain that damage has not occurred during shipment.

Note

Do *not* discard any packing materials until you have completed your inspection and are sure the unit arrived safely.

If you find any damage, notify your carrier and MKS immediately. If it is necessary to return the unit to MKS, obtain an RMA (Return Material Authorization) Number from the MKS Service Center before shipping. Please refer to the inside of the back cover of this manual for a list of MKS Calibration and Service Centers.

Unpacking Checklist

Standard Equipment:

- Type 627F Unit
- Type 627F Instruction Manual (this book)

Optional Equipment:

- Electrical Connector Accessories Kit:
627F-K1 (includes a mate for the I/O connector)
- Most MKS Power Supply/Readouts
- Most MKS Pressure, Flow, Flow Ratio, and Throttling Valve Controllers
- RM-6 Rack Mount Kit:
19" rack accommodates 1 or 2 readouts and/or controllers
- Interface Cables (refer to Table 5, page 20)

Interface Cables

As of July 20, 2009, most products shipped to the European Community must comply with the EMC Directive 2004/108/EC, which covers radio frequency emissions and immunity tests. In addition, as of January 1, 1997, some products shipped to the European Community must also comply with the Product Safety Directive 92/59/EC and Low Voltage Directive 73/23/EC, which cover general safety practices for design and workmanship. MKS products that meet these requirements are identified by application of the CE Mark.

To ensure compliance with EMC Directive 2004/108/EC, an overall metal braided shielded cable, properly grounded at both ends, is required during use. No additional installation requirements are necessary to ensure compliance with Directives 92/59/EC and 73/23/EC.

Note



1. An overall metal braided, shielded cable, properly grounded at both ends, is required during use to meet CE specifications.
2. To order an overall metal braided shielded cable, add an “S” after the cable type designation. For example, to order a cable to connect a 627F unit to a 651 controller, use part number CB259-5-10; for a metal braided shielded cable use part number CB259S-5-10.

You can purchase interface cables to all MKS companion products from MKS (refer to Table 5), or optionally you can make cables that meet the appropriate specifications. For cables connecting to non-MKS products, MKS can provide normal shielding or braided shielded cable assemblies in a nominal 10' (3m) length, terminating in flying leads (pigtail) fashion at both ends.

Overall metal braided shielded cable assemblies, properly grounded at both ends, are recommended if the environment contains high EMI/RFI noise.

Interface Cables		
To Connect the 627F Unit To...	Use the MKS Cable...	
	Standard	Shielded
PDR-C-1C/2C, PDR-5B Power Supply/Readouts	CB127-1-10	CB127S-1-10
146, 186, 651, 652, 660 Controllers	CB259-5-10	CB259S-5-10

Table 5: Interface Cables

Generic Shielded Cable Guidelines

Should you choose to manufacture your own cables, follow the guidelines listed below:

1. The cable must have an overall metal *braided* shield, covering all wires. Neither aluminum foil nor spiral shielding will be as effective; using either may nullify regulatory compliance.
2. The connectors must have a metal case which has direct contact to the cable's shield on the whole circumference of the cable. The inductance of a flying lead or wire from the shield to the connector will seriously degrade the shield's effectiveness. The shield should be grounded to the connector before its internal wires exit.
3. With very few exceptions, the connector(s) must make good contact to the device's case (ground). "Good contact" is about 0.01 ohms; and the ground should surround all wires. Contact to ground at just one point may not suffice.
4. For shielded cables with flying leads at one or both ends; it is important at each such end, to ground the shield *before* the wires exit. Make this ground with absolute minimum length. (A $\frac{1}{4}$ inch piece of #22 wire may be undesirably long since it has approximately 5 nH of inductance, equivalent to 31 ohms at 1000 MHz). After picking up the braid's ground, keep wires and braid flat against the case. With very few exceptions, grounded metal covers are not required over terminal strips. If one is required, it will be stated in the Declaration of Conformity or in the instruction manual.
5. In selecting the appropriate type and wire size for cables, consider:
 - A. The voltage ratings.
 - B. The cumulative I^2R heating of all the conductors (keep them safely cool).
 - C. The IR drop of the conductors, so that adequate power or signal voltage gets to the device.
 - D. The capacitance and inductance of cables which are handling fast signals, (such as data lines or stepper motor drive cables).
 - E. That some cables may need internal shielding from specific wires to others; please see the instruction manual for details regarding this matter.

Product Location and Requirements

Ambient Operating Temperature

The acceptable ambient operating temperature range for the 627F transducer is 15° to 40° C (59° to 104° F). The unit is temperature controlled at 45° C (113° F).

Note

The maximum temperature specification is provided for general guidance under ideal conditions. If the switch is located in an enclosed environment or where air flow is limited or impeded in any way please consult your local MKS office for additional guidance.

Power Requirements

The 627F transducer requires an external power source capable of supplying ± 15 VDC ($\pm 5\%$) at ≤ 250 mA.

Noise and ripple should be less than 20 mV peak-to-peak. You may use any readout device which has input capabilities of less than 0 to greater than 10 VDC, and impedance greater than 10K ohms. The power is introduced to the unit through the Interface connector on the top panel of the transducer (refer to Figure 4, page 30).

Setup

Dimensions

Note



All dimensions are listed in inches with millimeters referenced in parentheses. The tolerances for the dimensions are ± 0.1 inches (X.X) and ± 0.01 inches (X.XX).

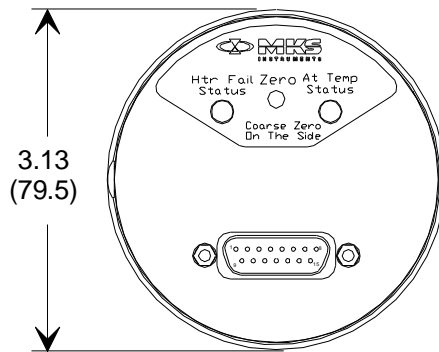

Figure 1: Top View Dimensions
(shown with the optional heater status LEDs)

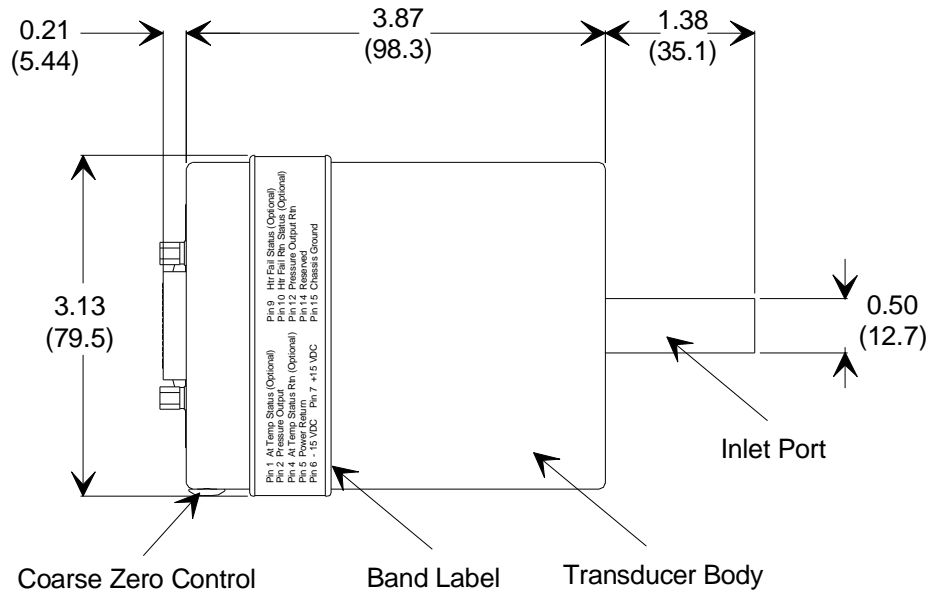

Figure 2: Side View Dimensions

Fittings

The 627F transducer is available with the following fittings:

- ½" diameter (12.7 mm) tubulation
- Swagelok® 8-VCR® (female)
- Mini-CF (rotatable)
- NW16-KF
- NW25-KF
- Swagelok 8-VCO® (female)

Mounting Instructions

Mount the transducer with the inlet port pointing (vertically) downward. The transducer port will easily carry the weight of the transducer.

Although the unit can be mounted in any orientation, mounting it as suggested allows any foreign matter entering the pressure port to fall away from the diaphragm.

Isolate the unit from vibration as much as possible. When not subject to gas damping at low pressure, the diaphragm may become susceptible to resonance. The low range transducers (≤ 1 Torr) are very sensitive and you should isolate them from any vibration that exists. Remember to isolate the vibration through the cable as well as through the port.

Electrical Information

Grounding

Note



The ground of any external power supply and readout should be the same as the transducer ground (chassis ground) to minimize any possible ground loops which can affect the performance and stability of the system.

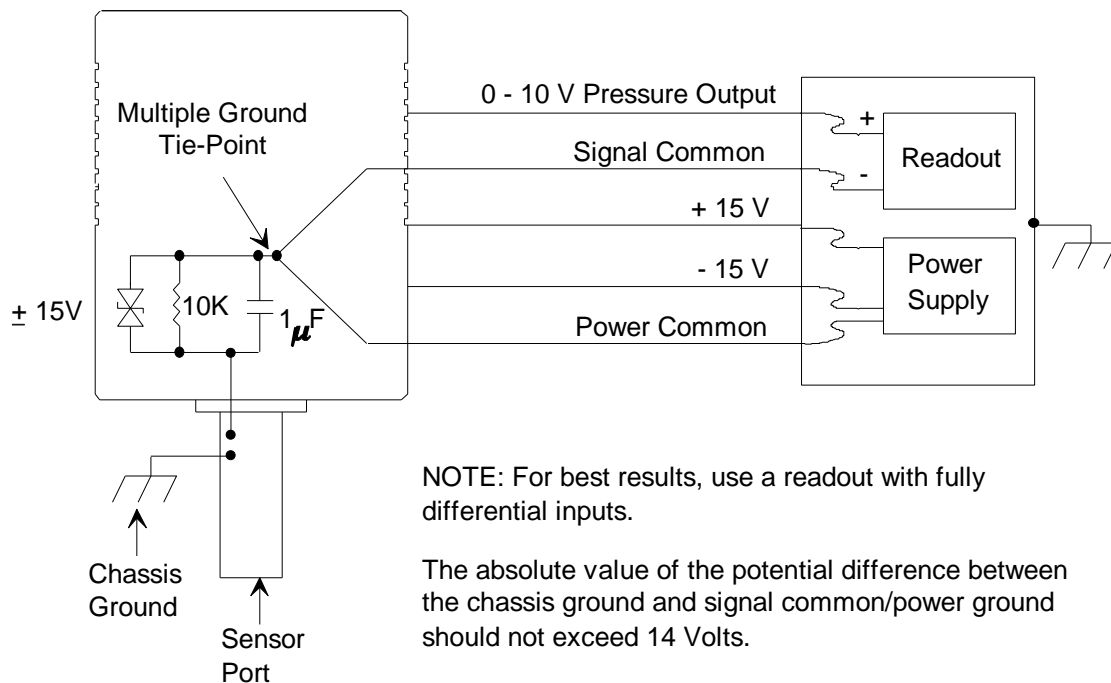

Figure 3: Example Power, Signal, and Chassis Grounding Scheme

Interface Connector

The 15-pin male Type “D” Interface connector on the top of the unit (refer to Figure 4, page 30) provides access to the power input and heater status pins. The pinout is listed in Table 6, page 27. The connector is available with either thread locks or slide locks.

Thread Locks

The 15-pin connector with thread locks utilizes threaded posts onto which the mating connector is mechanically fastened using screws. This is the standard MKS style Type “D” connector.

Slide Locks

The 15-pin connector with slide locks utilizes slotted posts onto which the mating connector is mechanically fastened using a slide mechanism which engages the slots in the posts.

Note

Standard MKS interface cables are not available for use with units configured with a slide lock connector.

Interface Connector Pinout	
Pin Number	Assignment
1	At Temperature Status* or Reserved
2	Pressure Signal Output
3	No Connection
4	At Temperature Status Return* or Reserved
5	Power Return (Power Common)
6	-15 VDC
7	+15 VDC
8	No Connection
9	Heater Failure Status* or Reserved
10	Heater Failure Status Return* or Reserved
11	No Connection
12	Pressure Signal Output Return (Signal Common)
13	No Connection
14	Reserved
15	Chassis Ground
<i>* Valid only with the heater status LED option.</i>	

Table 6: Interface Connector Pinout

Note

The “Reserved” pin assignment refers to a pin with an internal connection that may be assigned a function in the future. The “No Connection” pin assignment refers to a pin with no internal connection.

Start Up

After installation, allow your transducer to warm up until it is stabilized, then check the transducer zero to verify the proper output. Refer to *How To Adjust the Zero*, page 33, for complete instructions on adjusting the zero controls on the 627F unit.

Warm Up Time

Allow sufficient time for your transducer to warm up. The warm up times for 23° C ambient temperature conditions are:

- 2 hours for ≥ 1 Torr units
- 4 hours for < 1 Torr units

Note



The transducer must be *fully stabilized* before you make any zero adjustments.

Chapter Three: Overview

General Information

A complete pressure transducer system requires three components to convert pressure to a linear DC voltage output: a sensor, signal conditioner, and power supply. The 627F transducer contains two of the required components: the sensor and signal conditioner.

An MKS or MKS-compatible power supply is required to complete the pressure to DC voltage conversion. For a direct readout of the pressure measurement, a meter (analog or digital) is required.

Sensor

The 627F transducer is a variable capacitance sensor consisting of a pressure inlet tube (port) connected to a small chamber in the transducer body. One wall of this chamber is an elastic metal diaphragm. The front side of the diaphragm is exposed to the gas whose pressure is to be measured. The back, or *reference*, side of the diaphragm faces a rigidly mounted ceramic disc containing two electrodes. The reference side is permanently evacuated (10^{-7} Torr) and its vacuum is maintained with a chemical getter system.

The diaphragm deflects with changing absolute pressure (force per unit area) independently of the gas type or composition of the measured gas. This deflection causes an imbalance of the sensor electrode capacitances since the distance to the diaphragm is now different for each electrode. The imbalance of capacitances is converted to a DC voltage in the bridge. This bridge is excited by a precision constant frequency oscillator. The resultant signal is then linearized, zeroed, and amplified via the signal conditioner electronics, to produce a precise 0 to 10 VDC signal scaled to the range of the transducer.

In the heated 627F transducer, zero and span stability is further increased because the sensor and bridge electronics are temperature controlled. This thermal enclosure reduces the effects of ambient temperature changes by a factor of at least 35 (that is a 35° C change in ambient temperature will produce less than a 1° C change inside the thermal housing).

Signal Conditioner/Electronics

The signal conditioner contains state-of-the-art, RoHS-compliant, low impedance balanced bridge circuitry, self-compensated for thermal stability with ambient temperature changes. The output is a DC voltage which is linear with pressure. The transducer is then calibrated against a traceable reference standard to provide a 0 to 10 Volt DC output over the range of the transducer.

Instrument Components

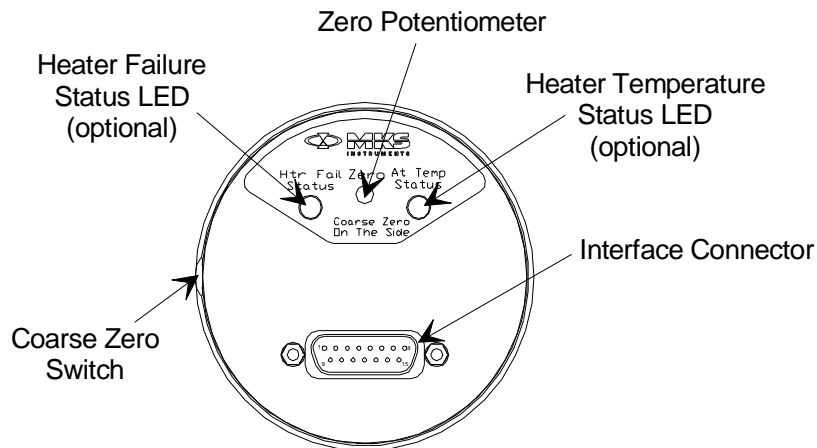

Figure 4: Top View of the 627F Transducer
(shown with the optional heater status LEDs)

Coarse Zero Switch

This multi-position switch adjusts the transducer zero if the ZERO potentiometer fails to provide sufficient zero adjustment. Refer to *How To Adjust the Coarse Zero Switch*, page 35, for more information.

Optional Heater Status LEDs and Semiconductor Switches

When the temperature of the sensor is within the controlled temperature window ($47^{\circ}\text{C} \pm 2^{\circ}\text{C}$) the “At Temperature Status” LED will illuminate green and the corresponding semiconductor switch (pins 1 and 4 on the Interface connector) will turn “on” (close). The transducer must continue to warm up until it reaches thermal equilibrium per the warm-up specifications. If a heater failure occurs, the bi-color “Htr Fail Status” LED will blink red (otherwise it will stay green), and the corresponding semiconductor switch (pins 9 and 10 on the Interface connector) will turn “off” (open). Refer to *Optional Semiconductor Switch Specifications*, page 40, for information.

Zero Potentiometer

This potentiometer adjusts the transducer zero. Refer to *How To Adjust the Zero Potentiometer*, page 34, for more information.

Interface Connector

The 15-pin male Type “D” Interface connector provides access to the power input and heater status pins. Refer to Table 6, page 27, for the connector pinout.

Labels

Note



The figures showing the instrument labels (Figures 5 through 7, and Figure 8, page 32) are not drawn to scale.

Top Panel Labels

The label on the top panel of the 627F unit identifies the ZERO potentiometer, and if ordered, the optional Heater Failure and Temperature Status LEDs.



Figure 5: Top Panel Label for Units without the Optional Heater Status LEDs



Figure 6: Top Panel Label for Units with the Optional Heater Status LEDs

Band Label

The band label, which is wrapped around the center of the transducer body, lists the pinout for the unit's 15-pin Interface connector (refer to Table 6, page 27). Note that pins 1, 4, 9, and 10 are "Reserved" for units without the optional heater status LEDs.

 MKS INSTRUMENTS	BARATRON PRESSURE TRANSDUCER <small>MADE IN USA</small>	Pin 1 At Temp Status (Optional)	Pin 9 Htr Fail Status (Optional)
		Pin 2 Pressure Output	Pin 10 Htr Fail Rtn Status (Optional)
		Pin 4 At Temp Status Rtn (Optional)	Pin 12 Pressure Output Rtn
		Pin 5 Power Return	Pin 14 Reserved
		Pin 6 -15VDC Pin 7 +15VDC	Pin 15 Chassis Ground

Figure 7: Band Label

Serial Number Label

The serial number label, located on the seam of the band label, lists the unit's serial number, model code, full scale range, input voltage, and output voltage. The label also displays the CE mark signifying compliance with the European CE regulations.



Figure 8: Serial Number Label

The options for your transducer are identified in the model code when you order the unit. Refer to *Appendix B: Model Code Explanation*, page 41, for more information.

Chapter Four: Operation

How To Adjust the Zero

All pressure transducers require initial and periodic zero adjustments. Prior to initial operation and during periodic maintenance you must check the transducer zero to verify the proper output. The zero can be set (or reset) by adjusting the ZERO potentiometer located on the top of the transducer (refer to *How To Adjust the Zero Potentiometer*, page 34) or at the front panel of any MKS Power Supply/Readout being used. If the ZERO potentiometer fails to provide sufficient adjustment, the COARSE ZERO switch may be used (refer to *How To Adjust the Coarse Zero Switch*, page 35).

To achieve the full dynamic range specified for the transducer, the zero adjustment **must** be made at a pressure less than the transducer's resolution (0.001% of FS). Low range transducers should be pumped for at least one hour after exposure to air to remove any moisture and to allow the pressure to stabilize. Zeroing a transducer above its stated minimum resolution creates a *zero offset* relative to true absolute pressure. All subsequent readings are then linear and accurate *relative to the offset value*.

Note

If available pressures are not sufficiently low to set the transducer zero, you may use a vacuum leak detector with sufficient vacuum pumping (to achieve proper zeroing pressures). In this case, mount the transducer on the leak detector *in the same plane of orientation as it will be during actual use*.

How To Adjust the Zero Potentiometer

To adjust the ZERO potentiometer:

1. Install the transducer in a system and connect a power supply/readout.
2. Power the transducer and allow it to warm up and stabilize.

Note



Allow 2 hours for ≥ 1 Torr units, and 4 hours for < 1 Torr units to warm up. Ensure that the transducer is *fully stabilized* before you adjust the zero.

3. Pump the unit down to a pressure below its resolution (0.001% of FS).

For best results, pump the transducer while it is warming up. Refer to Table 7 for the highest recommended pressure levels for proper zero adjustment.

Highest Pressures Suggested for Proper Zero Adjustment	
Full Scale Range (Torr)	Highest Pressure for Proper Zero Adjustment (Torr)
0.02	2×10^{-7}
0.05	5×10^{-7}
0.1	1×10^{-6}
1.0	1×10^{-5}
2.0	2×10^{-5}
10	1×10^{-4}
20	2×10^{-4}
100	1×10^{-3}
1000	1×10^{-2}

Table 7: Highest Pressures Suggested for Proper Zero Adjustment

4. Adjust the ZERO pot with a small screwdriver until the readout displays zero (0000).

Typically, the ZERO potentiometer provides ample control under normal conditions. However, if the ZERO potentiometer fails to provide sufficient adjustment, additional zero range capability is available with the COARSE ZERO switch, located on the side of the unit (refer to Figure 4, page 30). Refer to *How To Adjust the Coarse Zero Switch*, page 35, for more information.

How To Adjust the Coarse Zero Switch

Note  Use the COARSE ZERO switch *only* if the ZERO potentiometer fails to provide sufficient adjustment.

To adjust the COARSE ZERO switch:

1. Install the transducer in a system and connect a power supply/readout.
2. Power the transducer and allow it to warm up and stabilize.

Note  Allow 2 hours for ≥ 1 Torr units, and 4 hours for < 1 Torr units to warm up. Ensure that the transducer is *fully stabilized* before you adjust the zero.

3. Pump the unit down to a pressure below its resolution.
For best results, pump the transducer while it is warming up. Refer to Table 7, page 34, for the highest recommended pressure levels for proper zero adjustment.
4. Center the ZERO pot located at the top of the transducer by adjusting the screw to leave an equal amount of adjustment both clockwise and counterclockwise.
5. Remove the plug that covers the COARSE ZERO switch.
Refer to Figure 4, page 30.
6. Turn the COARSE ZERO switch to a position that produces the output signal closest to 0 Volts.
7. Adjust the ZERO pot to bring the output to exactly 0 Volts.
Refer to *How To Adjust the Zero Potentiometer*, page 34, for more information.
8. Cover the COARSE ZERO switch with the plug removed in step 5.

Suggested Pressures for Reading and Control

The lowest suggested pressures for reading and control with the 627F transducer are listed in Table 8.

Lowest Suggested Pressures for Reading and Control		
Full Scale Range (Torr)	Lowest Suggested Pressure for Reading (Torr)	Lowest Suggested Pressure for Control (Torr)
0.02	1×10^{-5}	1×10^{-4}
0.05	2.5×10^{-5}	2.5×10^{-4}
0.1	5×10^{-5}	5×10^{-4}
1.0	5×10^{-4}	5×10^{-3}
2.0	1×10^{-3}	1×10^{-2}
10	5×10^{-3}	5×10^{-2}
20	1×10^{-2}	1×10^{-1}
100	5×10^{-2}	5×10^{-1}
1000	5×10^{-1}	5×10^0

Table 8: Lowest Suggested Pressures for Reading and Control

Lowest Suggested Pressure Available for Reading

The pressures listed in the middle column of Table 8 reflect reliable and practical pressures for different range transducers. Lower readings may be obtained in environments which have stable temperature and air flow.

Lowest Suggested Pressure to Use for Control

The pressures listed in the last column of Table 8 are for reference, and represent the pressure reading of the transducer at 50 mV signal output. A DC signal of at least 50 mV is the recommended minimum signal level to use when integrating any transducer into complex processing systems.

Chapter Five: Maintenance and Troubleshooting

General Information

If the 627F transducer fails to operate properly upon receipt, check for shipping damage, and check the cables for correct continuity. Any damage should be reported to the carrier and MKS Instruments immediately.

If there is no obvious damage and the continuity is correct, check your instrument using the troubleshooting chart (refer to Table 9, page 38). If the transducer performance does not improve and it is necessary to return the unit to MKS for service, obtain an ERA Number (Equipment Return Authorization Number) from any MKS Calibration and Service center before shipping. Please refer to the inside back cover of this manual for a list of MKS Calibration and Service Centers.

Maintenance

In general, the 627F transducer requires no maintenance other than proper installation and operation, and an occasional zero adjustment. Periodically, check for wear on the cables and inspect the enclosure for visible signs of damage.

Zero Adjustment

The transducer zero can be set (or reset) by adjusting the ZERO potentiometer on the top panel of the unit (refer to Figure 4, page 30), or at the front panel of any MKS or MKS-compatible power supply being used. Refer to *How To Adjust the Zero*, page 33, for complete instructions on how to adjust the transducer's zero controls.

Note



1. In production operations such as semiconductor manufacturing, verify the transducer zero (and adjust if necessary) each time the equipment is shut down for routine maintenance.
 2. The zero adjustments are the **only** adjustments that can be made in the field. Return the transducer to MKS Instruments for other adjustments, calibration, or servicing.
-

Troubleshooting

Troubleshooting Chart		
Symptom	Possible Cause	Solution
Overrange positive or negative signal	A shorted transducer or a damaged interconnect cable (transducer to electronics module).	Measure supply voltages at the connector. Inspect cable and transducer. Replace if necessary.
Measurement slowly goes positive over time	Overpressure and/or a build-up of contamination in the measurement cavity.	Return to MKS for servicing or transducer replacement.
Unstable zero output	The ambient temperature may be too high. <i>or</i> The ambient temperature is varying over a wide range.	Ensure the ambient temperature is within product requirements; refer to <i>Appendix A: Product Specifications</i> , page 39.

Table 9: Troubleshooting Chart

Appendix A: Product Specifications

Electrical Specifications

CE Compliance Electromagnetic Compatibility ¹ Product Safety Requirements	EMC Directive 2004/108/EC Product Safety Directive 92/59/EC
RoHS (Restriction of Hazardous Substances) Compliance	Fully compliant with Directive 2002/95/EC
Input Power Requirement Voltage Current	±15 VDC ±5% ≤ 250 mA
Signal Output	0 to +10 VDC, 110% overrange, active zero

Environmental Specifications

Ambient Operating Temperature Range	15° to 40° C (59° to 104° F)
Maximum External Case Temperature	50° C (122° F)
Storage Humidity Range	25 to 95% Relative Humidity, non-condensing
Storage Temperature Range	-20° to 80° C (-4° to 176° F)

Performance Specifications

Accuracy (non-linearity, hysteresis, and non-repeatability) ≥ 1 Torr units 0.25, 0.1, and 0.05 Torr units 0.02 Torr units	±0.12% of Reading ±0.15% of Reading ±0.25% of Reading
Internal Volume	6.3 cc
Leak Integrity	Internal to external <10 ⁻⁹ scc/sec He
Overpressure Limit Without Damage	45 psia (310 kPa)
Pressure Ranges (Torr FS)	0.02, 0.05, 0.1, 0.25, 1.0, 2.0, 10, 20, 100, 1000, 2000, 5000, 10000, 15000, 20000
Resolution	0.001% (1 x 10 ⁻⁵) of FS

¹ An overall metal braided shielded cable, properly grounded at both ends, is required during use.

Performance Specifications (Continued)

Temperature Coefficients	
Zero	
≥ 1 Torr units	0.002% FS/ °C
0.1 and 0.25 Torr units	0.005% FS/ °C
0.05 Torr units	0.015% FS/ °C
0.02 Torr units	0.030% FS/ °C
Span (all ranges)	0.02% Reading/ °C
Time Response	< 20 msec (< 40 msec for ≤ 1 Torr units)
Warm Up Time (for 23° C ambient temperature conditions)	
≥ 1 Torr units	2 hours
< 1 Torr units	4 hours
Zero Adjustment Range	
Zero Potentiometer	$\pm 1.0\%$
Coarse Zero Switch	$\pm 20\%$

Physical Specifications

Fittings	$\frac{1}{2}$ " Diameter (12.7 mm) tubulation, Swagelok® 8-VCR® (female), Mini-CF (rotatable), NW-16-KF, NW-25-KF, Swagelok 8-VCO® (female)
Interface Connector	15-pin male Type "D"
Weight	1.5 lbs (0.68 Kg)
Wetted Materials	Inconel® and Incoloy®. Some fittings may be built from 300-series stainless steel.

Optional Semiconductor Switch Specifications

Current Carrying Capacity	10 mA, maximum
Saturation Voltage	0.4 V, maximum
Open Circuit Voltage	28 V, maximum
Zener Protection	28 V, nominal

Due to continuing research and development activities, these product specifications are subject to change without notice.

Appendix B: Model Code Explanation

Model Code

The options of your transducer are identified in the model code when you order the unit. The model code is identified as follows:

627F XXX Y Z B C

where:

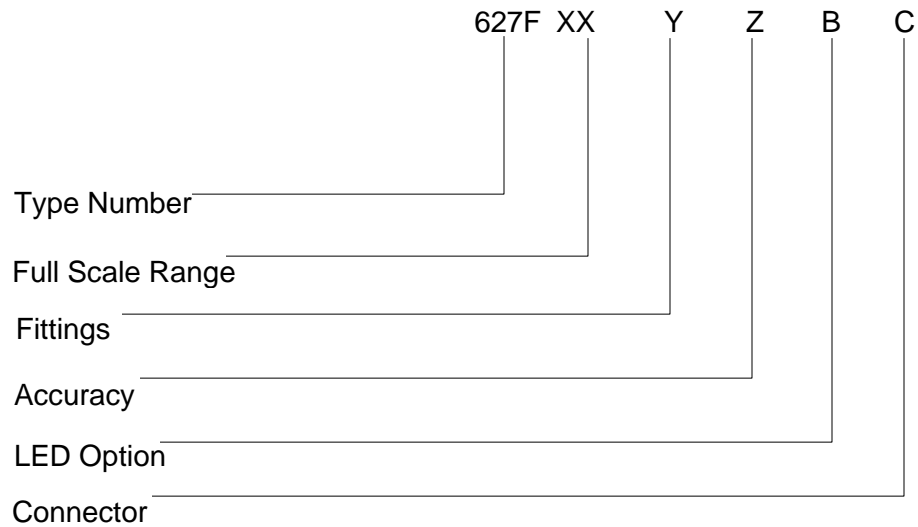

Type Number (627F)

This designates the model number of the instrument.

Full Scale Range (XXX)

The full scale range in Torr is indicated by a two digit / one letter code.

Full Scale Range - Torr

Ordering Code

0.02	U2T
0.05	U5T
0.1	.1T
0.25	RET
1.0	01T
2.0	02T
10	11T
20	21T
100	12T
1000	13T
2000	23T

5000	53T
10,000	14T
15,000	RBT
20,000	24T

Fittings (Y)

Six types of fittings are available, designated by a single letter code.

Fittings	Ordering Code
½" Diameter tubulation	A
Swagelok 8-VCR (female)	B
Mini-CF (rotatable)	C
NW16-KF	D
NW25-KF	Q
Swagelok 8-VCO female	E

Accuracy (Z)

Three specifications for accuracy are available, designated by a single letter code.

Accuracy	Ordering Code
0.12% of Reading (≥ 1 Torr units)	C
0.15% of Reading (0.25, 0.1, and 0.05 Torr units)	D
0.25% of Reading (0.02 Torr units)	E

LED Option (B)

The unit is available with or without the heater status LEDs, designated by a single letter code.

LED Option	Ordering Code
Standard (No status LEDs)	1
Heater Failure / Heater Temperature Status LEDs	2

Connector (C)

Two configurations of the 15-pin Type "D" connector are available, designated by a single letter code.

Connector	Ordering Code
15-pin Type "D" connector with thread locks	B
15-pin Type "D" connector with slide locks	P

Index

A

Accuracy, 39, 42

B

Band label, 31

C

Cables, 20–21

CE mark, 17, 20, 32

Coarse zero switch, description of, 30

Customer support, 18

F

Fittings, 24, 40, 42

Full scale ranges, 39, 41

G

Grounding, 25

H

Heater status option, 30, 42

I

Interface connector, 26, 30
options, 42

L

Labels

band label, 31

serial number, 32

top panel, 31

M

Maintenance, 37

Manual organization, 18

Model code, 41

Mounting instructions, 24

O

Optional equipment, 19

Options

heater status LEDs, 30, 42

Interface connector, 26, 42

P

Power requirements, 22

Pressure

highest for zero adjustment, 34

lowest for control, 36

lowest for reading, 36

R

Returning the product, 18, 19, 37

RoHS (Restriction of Hazardous
Substances), 17, 39

S

Safety information, 1–16

Sensor, description of, 29

Serial number label, 32

Setup

grounding, 25

mounting instructions, 24

power requirements, 22

Signal Conditioner/Electronics, 29

Slide locks, 26

Specifications, 39–40

Standard equipment, 19

Start up, 28

T

Temperature

operating, 22, 39

storage, 39

Thread locks, 26

Top panel labels, 31

Troubleshooting, 38

W

Warm up time, 28, 40

Z

Zero adjustment, 37

coarse zero switch, 35

zero pot, 34

Zero pot, description of, 30