



# **Instruction Manual**

## **Compound Molecular Pump**

**EBT70F-20**

**Be sure to read and understand all warnings in this manual before using the product.**

**Keep this manual readily available for reference.**

**EBARA Corporation**



## Safety





This section provides important safety information. Be sure to read this section thoroughly before using the compound molecular pump EBT70F-20, and follow all instructions.

Note that the scope of the cautions and warnings in this manual are limited to the range of our expectation. For your safety, follow all general rules (laws and regulations) in addition to the instructions provided herein.







EBARA Corporation reserves the right to make changes to the product specifications without notice, so as to maintain and improve the quality of the product. For this reason, the contents of this manual may not match exactly with the actual product.

## Symbols and Definitions









The following symbols and definitions are used for the warnings and cautions in this manual.

 Warning	<p>Important information for preventing serious bodily injuries. Failure to follow instructions labeled with this symbol may result in serious injury or death.</p>
 Caution	<p>Important information for safe use of the pump. Failure to follow instructions labeled with this symbol may result in injury and/or property damage.</p>
 Information	<p>Information that may be useful when using the pump.</p>
 Warning	<p style="text-align: center;"><b>Instruction Manual</b></p> <p>This instruction manual (hereinafter, "this manual") provides safety notes, operation procedures, maintenance and inspection procedures for the pump. All personnel must read and understand the contents of this manual and handle the pump appropriately.</p>









 Warning	<b>Ambient temperature and humidity</b>
	Do not use the pump in an area of high temperature or high humidity.
 Warning	<b>Water drip</b>
	Do not use the pump where water drips.
 Warning	<b>Installation</b>
	Use a truck or a lift in transportation and installation. Secure the pump to a mount or floor and use the pump. Do not hang the pump above a walkway. If the pump is to be mounted to equipment, read this manual thoroughly before designing the equipment and design the equipment appropriately.
 Warning	<b>Inspection</b>
	Do not place your hands or foreign matters inside the pump.
 Warning	<b>Process gas</b>
	Do not use the pump to exhaust gallium, mercury, their compounds, or corrosive gas. Doing so may result in pump failure.
 Warning	<b>Overhaul</b>
	If you could not help using the pump to exhaust toxic or reactive or flammable gas, construct the system that avoids the dangers of suction or explosion, etc. And purge the pump with inert gas before removing it from the equipment. Wear protective equipment to prevent exposure to the gas. When transporting the pump, seal the inlet, purge port, vent port, and outlet.



 Warning	<b>Disassembly and modification</b>
	Do not disassemble or modify the pump. It may result in serious accidents, causing death, serious injury, and/or property damage.
 Warning	<b>Temporary inlet flange</b>
	The temporary inlet flange is only for shipping. Do not use it for any other purpose.
 Warning	<b>Air inrush</b>
	Do not make air inrush into the pump when operating the pump. It may result in injury and/or pump damage.
 Warning	<b>Heat emission</b>
	The pump generates heat in operation. Do not touch the pump in operation, or you may get burned.
 Warning	<b>Pump detaching</b>
	Purge the pump with the inert gas and return it to the atmospheric pressure. Detach the pump when the rotor has stopped completely.
 Warning	<b>Outlet piping</b>
	Do not exhaust process gas directly in a room. It may result in poisoning or choke. Make the outlet piping to prevent poisoning and choke with process gas.
 Caution	<b>Dust, flammable gas and corrosive gas</b>
	Do not use the pump in an area exposed to dust, flammable gas or corrosive gas.
 Caution	<b>Magnetic field and electric field</b>
	Do not use the pump in a strong magnetic field or electric field.
 Caution	<b>Vibration</b>
	Do not use the pump in an area with a lot of vibration.



 Caution	<b>Dewfall</b>
	Do not use the pump in a dewfall area.
 Caution	<b>Radiation</b>
	Do not use the pump in a radiation area.
 Caution	<b>Sea breeze</b>
	Do not use or store the pump where it is exposed to salt-laden atmosphere.
 Caution	<b>Cable connection</b>
	Do not disconnect the cable when operating the pump.
 Caution	<b>Start and stop</b>
	Do not start/stop the pump by turning input power on/off.
 Caution	<b>Backing pump</b>
	Connect a backing pump to the pump before using the pump.
 Caution	<b>Allowable gas flow rate</b>
	Allowable gas flow rate of the pump is as follows. The allowable gas flow rate will vary depending on exhaust pressure, ambient temperature, and so on. <b>EBT70FRAB-20 / EBT70FCAB-20</b> Nitrogen : 37 Pa-L/s[20 sccm] Argon: 18 Pa-L/s[10 sccm] <b>EBT70FRNB-20 / EBT70FCNB-20</b> Nitrogen : 18 Pa-L/s[10 sccm] Argon: 9.2 Pa-L/s[5 sccm] If you expect to exceed the allowable gas flow rate, consult EBARA Corporation prior to use.



## **Warranty and Liability**

**EBARA Corporation guarantees the quality of its pumps, controllers, and their accessories as described in the included "Standard Warranty Certificate". Note, however, that handling the pump in manners not described in this manual will void all warranty.**

**Use of the pumps and controllers under atypical conditions without prior consent from EBARA Corporation may also void the warranty.**



## Contents

	Page
<b>1. Characteristics</b> -----	<b>8</b>
<b>2. Unpacking and carrying</b> -----	<b>8</b>
2-1. Unpacking	
2-2. Carrying	
<b>3. Installation</b> -----	<b>10</b>
3-1. Dimensions	
3-2. Name of pump parts	
3-3. Nameplates	
3-4. Conditions of usage	
3-5. Cooling	
3-6. Securing	
<b>4. Cable connection</b> -----	<b>18</b>
<b>5. Vacuum piping</b> -----	<b>18</b>
5-1. Inlet piping	
5-2. Backing pump selection	
5-3. Outlet piping	
5-4. Purge port piping	
5-5. Vent port piping	
<b>6. Operation</b> -----	<b>21</b>
6-1. Precaution before operation	
6-2. Operation	
6-3. Procedure of start / stop	
6-4. Start / stop during operation	
<b>7. Baking</b> -----	<b>23</b>
<b>8. Maintenance</b> -----	<b>24</b>
8-1. Vibration	
8-2. Dust	
8-3. Reaction product	
8-4. Gas handling	
8-5. Exchange of bearing	
8-6. Air inrush	
8-7. Caution about operation at low temperature	
<b>9. Storage</b> -----	<b>25</b>



<b>10. Overhaul and service recommended</b>	-----	<b>26</b>
<b>11. Disposal</b>	-----	<b>27</b>
<b>12. Specifications</b>	-----	<b>27</b>
<b>13. Contacting EBARA</b>	-----	<b>28</b>





**1. Characteristics**

- 1) A compound molecular pump is a vacuum pump which pumps out gases mechanically. The rotor, which consists of turbine stages and helical groove stages, rotates at high speed, and carries gas molecules from the inlet to the outlet port.
- 2) Compound molecular pump EBT70F-20 is a controller-separated type. This pump is industrial equipment. It uses grease-lubricated ball bearings to support a rotor, which spins at a high speed to pump gas molecules from the inlet to the outlet.
- 3) The controller ETC76 is a high frequency inverter. ETC76 starts up the pump in a short time with optimum control. Refer to the instructions manual of ETC76.
- 4) ETC76 realizes small size, light weight and high reliability by sensorless and brushless motor control.
- 5) The pump and the controller are conformed to the regulations and the directives as follows. However, conformed cable length is 20m or less.

UL61010-1:2004 (US72090200: TUV Rheinland)

SEMI S2-0706

LVD (2006/95/EC)

EMC Directive (2004/108/EC)

CE marking <sup>note)</sup>

\*note) Refer to the “CE declaration of conformity” in the end of this manual.

**2. Unpacking and carrying**

**2-1. Unpacking**

Check the following items before unpacking.

A: Unpacking

Table 1 lists the pump weight.

Table 1 Pump weight

Pump model	Weight
EBT70FRAB-20 / EBT70FRNB-20	2.6 kg [6 lbs.]
EBT70FCAB-20 / EBT70FCNB-20	4.6 kg [10 lbs.]

B: Damage to the contents

Should any of the package contents be damaged or defective, please contact EBARA Corporation prior to use.



C: Accessories

The standard package includes following accessories. Should any item be missing, contact EBARA Corporation.

- |  |         |
|--|---------|
| (1) Instruction manual                           | 1 copy  |
| (2) Inlet protective screen                      | 1 set   |
| (3) Temporary flange (cap) for Intake protection | 1 set   |
| (4) Protection cap for outlet                    | 1 piece |

**2-2. Carrying**

When carrying the pump, or when mounting/dismounting the pump to/from the equipment, use a truck or a lift etc.

Keep the pump stable. Keep the pump from impact.

 Caution	<b>Avoid applying a shock onto the pump. Keep the pump stable.</b>
---	--

 Information	<b>We suggest that you keep the temporary flange (cap) and the protection cap stored for reuse when dismantling the pump. We suggest that you keep the packaging stored for reuse.</b>
--	--

### 3. Installation

#### 3-1. Dimensions

	A	B	C	D	E	F	G	H
EBT	ISO-R63	95	12	50.5	144.5	115.5	115.5	116
70F-20	CF63	114	18	76	170	141	141	141.5

#### EBT70FRAB-20 / EBT70FCAB-20

(Forced air cooling type)

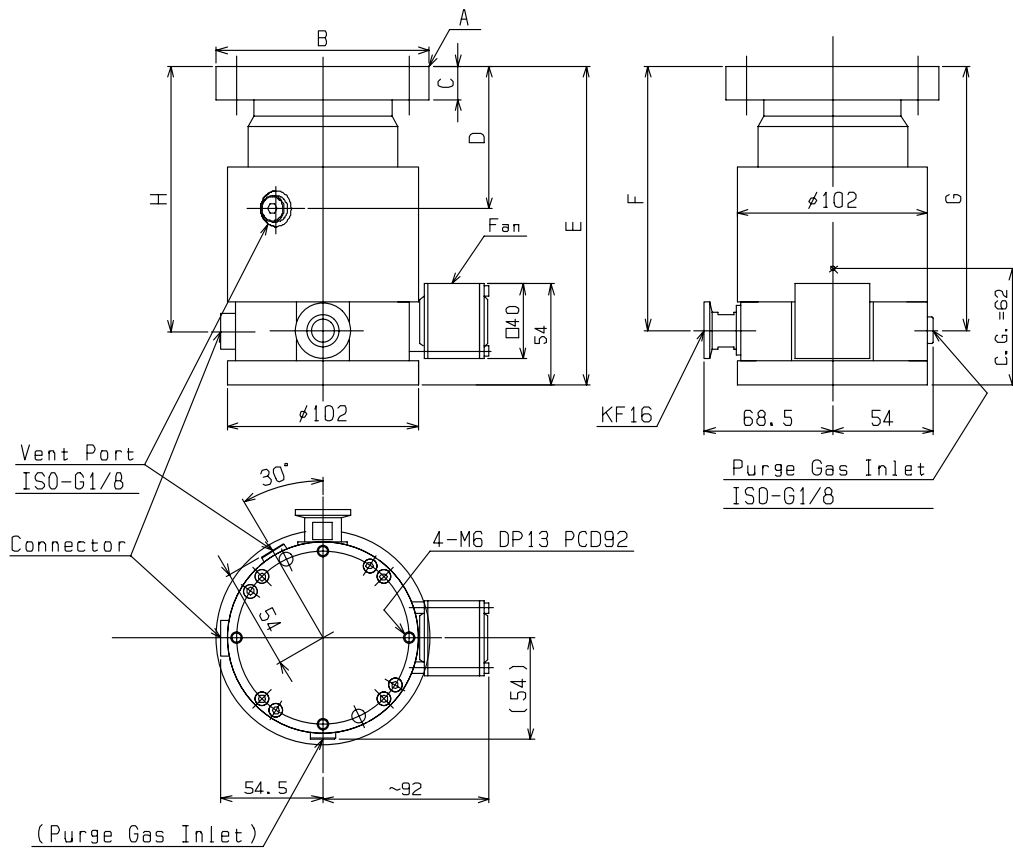

**EBT70FRNB-20 / EBT70FCNB-20**  
**(Free convection air cooling type)**

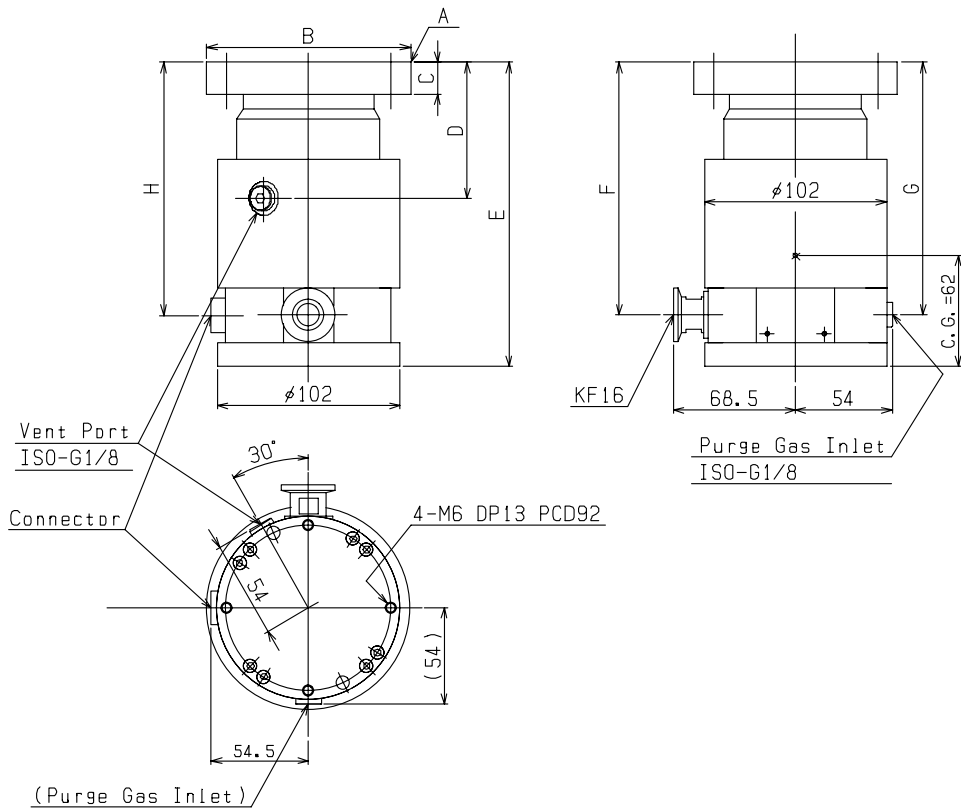

### 3-2. Name of pump parts

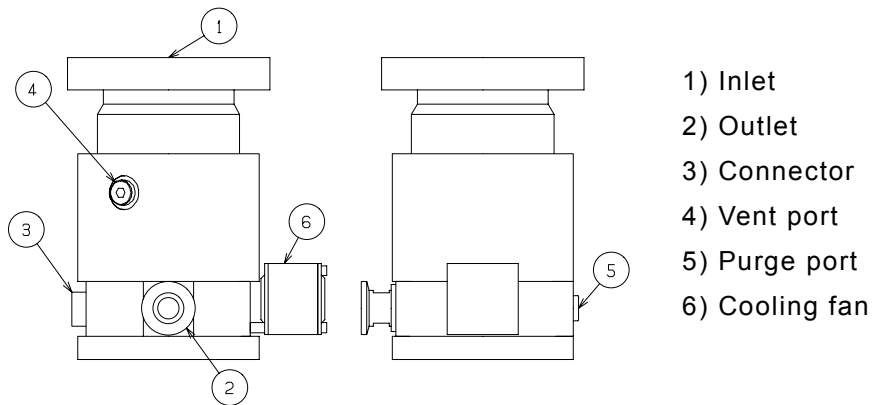

Figure 1 Name of pump parts

### 3-3. Nameplate

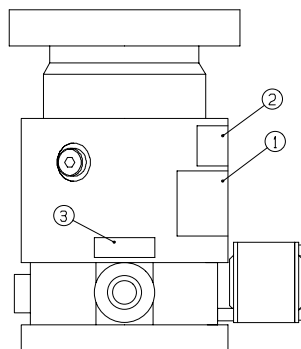

Figure 2 Nameplates

#### 1) Main nameplate

Indicates the pump's model name, serial number, and date of manufacture.

COMPOUND MOLECULAR PUMP	
MODEL	EBT*****
SER. NO.	*****
DATE	**-*0**
EBARA Corporation	
MADE IN JAPAN	

#### 2) Warning labels

Indicates pump weight.



#### 3) Warning label

Connect to the backing pump.

**Section 1.01**



**3-4. Conditions of usage**

1) Ambient temperature

 <b>Caution</b>	<b>The pump becomes hot during operation. Ambient temperature in operation must not exceed 38°C (100°F). If the temperature exceeds, it may cause pump failure.</b>
--	---

2) Ambient humidity or water drip or dewfall

Ambient relative humidity must not exceed 85 %.

 <b>Caution</b>	<b>If you use the pump in an area with high humidity or water drips or dew falls, it may cause pump failure.</b>
--	--

3) Dust

 <b>Caution</b>	<b>Do not use the pump in an area exposed to dust. It may cause pump failure.</b>
--	---

4) Toxic/explosive/flammable gas

 <b>Caution</b>	<b>Do not use the pump in an area with toxic gas such as acid, alkali, corrosive gas and so on. Also, do not use the pump in an area with explosive gas or flammable gas. It may cause pump failure.</b>
--	--

5) Magnetic field

Do not operate the pump within a magnetic field. The pump has a tolerance for magnetic fields of up to 2.5 mT (25 Gauss) in the direction perpendicular to the axis, and up to 15 mT (150 Gauss) in the direction of the axis. If the pump must be operated within a magnetic field that exceeds the tolerated value, use magnetic shielding. Also, consult with EBARA Corporation.

 <b>Caution</b>	<b>If the pump is operated within a magnetic field, the rotor temperature will increase, and may cause rotor damage and pump failure.</b>
--	---



6) External shocks and vibrations

 <b>Caution</b>	<b>Do not apply shocks and vibrations to the pump during operation. It may cause pump failure.</b>
--	--

7) Radiation

 <b>Caution</b>	<b>Do not use the pump in a radiation area. It may cause pump failure.</b>
--	--

8) Sea breeze

 <b>Caution</b>	<b>Do not use or store the pump where it is exposed to salt-laden atmosphere.</b>
--	---

**3-5. Cooling**

Pump must be cooled during operation. When using EBT70FRAB-20/EBT70FCAB-20, connect the cooling fan integration and the controller with fan cable. Refer to section 4. When using EBT70FRNB-20/EBT70FCNB-20, prepare a cooling fan and use the pump within the allowable gas flow rate and ambient temperature.

Surface temperature of the pump must not exceed 50 °C (122 °F) during operation. Table 2 lists specifications of cooling fan integrated in EBT70FRAB-20/EBT70FCAB-20. When using EBT70FRNB-20/EBT70FCNB-20, prepare a fan equivalent to or larger than it.

Table 2 Specifications of cooling fan integrated

Flow rate	0.32 m <sup>3</sup> /min (11.3 CFM)
Input Voltage (polarity)	24 VAC (red plus / black minus)
Rated current (Power)	0.095A (2.28 W)

 <b>Caution</b>	<b>Surface temperature of the pump must not exceed 50 °C (122 °F) during operation. It may cause pump failure.</b>
--	--

 <b>Caution</b>	<b>Please secure clearance so as not to restrict air flow around the fan.</b>
--	---



**3-6. Securing**

Before mounting the pump, check that the vacuum seal surface of the pump's inlet and outlet are clean and intact.

 <b>Warning</b>	<p><b>If the rotor becomes damaged while the pump is in operation, a large torque will be generated. The torque causes the whole pump to try to rotate. Secure the pump for safety.</b></p>
--	---

 <b>Warning</b>	<p><b>Do not hang the pump above a walkway.</b>  <b>Use fixing bolts listed in Table 4 to secure the pump.</b>  <b>If you have difficulty in obtaining the bolts of Table 4, consult with EBARA Corporation before securing.</b></p>
--	--

 <b>Caution</b>	<p><b>Be careful not to contaminate and/or scratch the inlet and outlet. Do not touch inside the pump. The pump may not be able to get sufficient performance by leak and/or contamination.</b></p>
--	---

When designing the equipment, frame, mount or floor which the pump is to be fixed to, ensure that it can withstand the rotational torque applied by the pump, listed in table 3.

Table 3 Rotational torque by pump rotor breakage

Pump model	Torque
EBT70F-20	350 N · m





Use bolts those satisfy or exceed specifications in Table 4, and tighten all the bolts evenly and securely.

Table 4 Fixing bolts

Location		Bolt (Quantity and size)	P.C.D.	Recommended torque	Bolt material (property class)
Inlet flange	ISO-R63	4 – clamps (M8)	---	(15 -19.5 N·m)	SUS304 (grade 70 or higher) or SCM435 (grade 8.8 or higher)
	CF63	8 - M8	92.1	15 - 19.5 N·m	
Bottom		4 - M6	92	6 - 7.5 N·m	

Secure the pump to the equipment or the mount at the inlet flange and/or at the bottom utilizing the threaded holes prepared for securing the pump. Figure 3 illustrates examples of securing.

When you secure the pump on the inlet only with clamps, apply lubricant such as molybdenum disulfide to the thread and the washer face. If lubricant is not applied, clamping force will be insufficient.

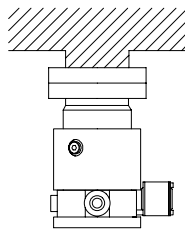

Example A

When the inlet flange of the pump installs to the rigid equipment, secure the pump with the bolts listed in Table 4 firmly.

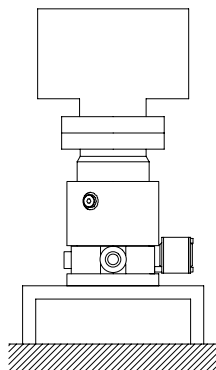

Example B

When the chamber installs to the inlet flange of the pump, secure the pump to the pump stand with the bolts listed in Table 4 and also secure the pump stand to the rigid floor or the frame firmly.

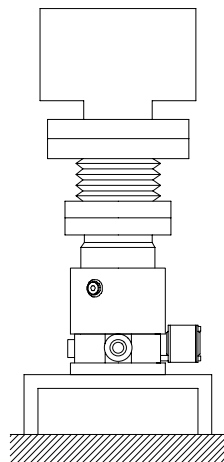

Example C

When the inlet flange of the pump installs to soft system such as bellows, secure the pump to the pump stand with the bolts listed in Table 4 and also secure the pump stand to the rigid floor or the frame firmly.

Figure 3 Examples of securing

#### 4. Cable connection

Table 5 lists the combination of the pump and the controller.

Table 5 Combination of Pump and Controller

Pump model	Controller model
EBT70F-20	ETC76

Figure 4 illustrates cable connection.

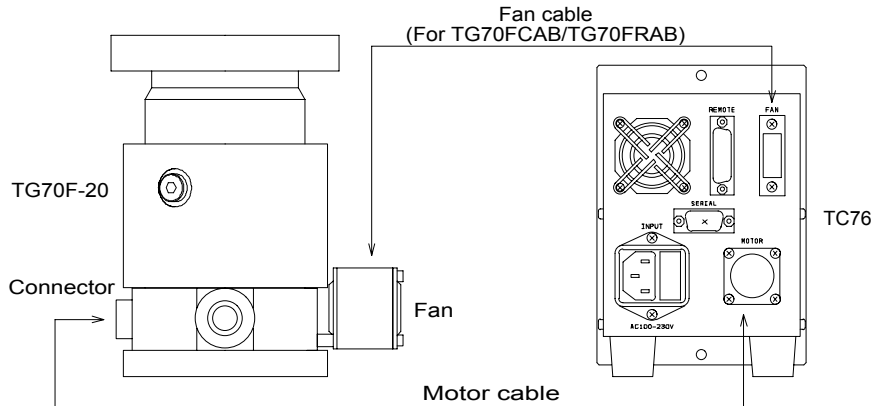



Figure 4 Cable connection

For details on the cable connection, refer to the instructions manual of ETC76.

 <b>Caution</b>	<b>When connecting the cables, set the pins to correct position, plug in the connector at a straight angle and fasten the coupling nut to the end.</b>
--	--

#### 5. Vacuum piping

##### 5-1. Inlet piping

- 1) Use piping made of materials with little outgassing, such as stainless steel and aluminum alloy.
- 2) When designing the piping, take conductance (ease of gas flow) into consideration.
- 3) Minimize the leakage from the piping and the equipment. To minimize outgassing, degrease and clean the internal surface of the piping.
- 4) When the pump is installed in a system, do not remove the protective screen at the inlet.  
The protective screen prevents foreign objects from falling into the pump.

 <b>Caution</b>	<b>Even with a protective screen, foreign objects may fall into the pump. It may cause issues and/or damage.</b>
--	--



5) Connected it surely so as not to leak when you connect piping.

**5-2. Backing pump selection**

The performance of the pump is affected by the capacity of the backing pump. When selecting the backing pump, refer to Table 6 and select a pump that meets the capacity recommendation.

Table 6 Recommended backing pump capacity

Pump model	Recommended backing pump capacity
EBT70F-20	≥ 25 L/min (0.88 CFM)

 <b>Caution</b>	<b>If the performance of the backing pump is low or becomes degraded, the pump may not perform at its best.</b>
--	---

 <b>Information</b>	<b>Use a trap or other measures to prevent the counter flow of oil mist into the pump. If the pump becomes contaminated by oil mist, it may not perform at its best.</b>
--	--

**5-3. Outlet piping**

- 1) For the piping connected to the pump, use piping made of stainless steel or aluminum alloy, or a metal flexible tube.
- 2) The performance of the pump is affected by the conductance of the piping. To minimize the effect of conductance, the piping should be as short as possible and as large in diameter as possible.
- 3) To prevent the pump from being affected by the vibration of the backing pump, use a metal flexible tube or a bellows.

Install the pump and the backing pump separately. Or, if installing them on the same mount, take anti-vibration measures.

- 4) Connect it securely, so as not to leak when you connect piping.

 <b>Warning</b>	<b>Do not exhaust process gas directly in a room. It may result in poisoning or choke. Make the outlet piping to prevent poisoning and choke with process gas.</b>
--	--

 <b>Caution</b>	<b>Install the pump and the backing pump, so that the pump is not affected by the vibration of the backing pump.</b>
--	--

 <b>Caution</b>	<b>Do not block the outlet port. Connect the outlet port to a backing pump.</b>
--	---

#### 5-4. Purge port piping

If the pump exhausts a gas with dust, purge the inside of the pump from purge port. Refer to Figure 5. In general, nitrogen is used as the purge gas. Set the purge gas flow rate to 9.2 Pa·L/sec (5 sccm). If you do not purge the pump, seal the purge port with a plug. Connect it securely, so as not to leak when you connect piping. Make sure that purge gas supply pressure is 0.2MPa (1kgf/cm<sup>2</sup>G, 14.3psiG) or lower.

	<b>Caution</b>	<b>If the flow rate of the purge gas is too large or too small, it may cause the performance of the pump to become degraded and/or cause pump failure.</b>
---	----------------	--

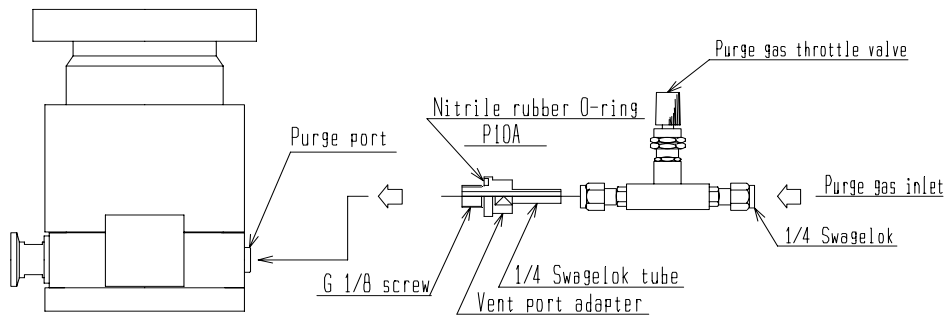

Figure 5 Example of purge port piping

#### 5-5. Vent port piping

If you want to stop the pump quickly, you can shorten the shutdown time very much by venting a gas from vent port.

Be sure that the pump is stopping, and open the vent valve. Figure 6 illustrates an example of vent port piping. Set the vent-gas flow rate no more than 184 Pa·L/sec (100 sccm). You can open the vent valve at the same time of sending Stop signal. Refer to Section 6-3. Connect it securely, so as not to leak when you connect piping.

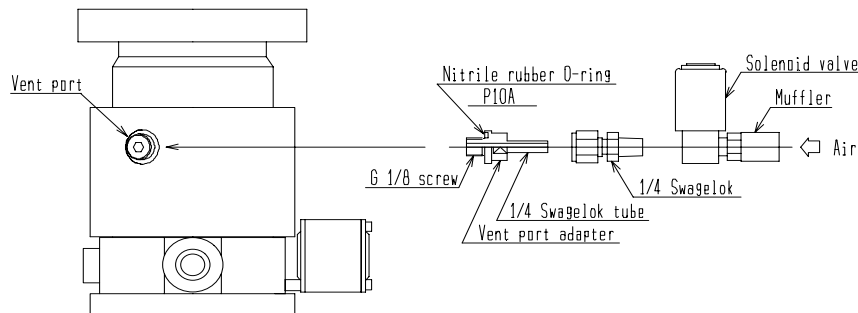

Figure 6 Example of vent port piping



**6. Operation**

**6-1. Precaution before operation**

- 1) Check the cable connection. Refer to Section 4.
- 2) The pump must be cooled during operation. Refer to Section 3-5.
- 3) Start the backing pump at first, and wait for the chamber pressure to drop to 260Pa (2.0Torr) before starting the pump. If you start the pump at high pressure of the chamber, the startup time will become longer, or it will fail to start up. Refer to the instructions manual of ETC76.
- 4) When pumping dust, purge the inside of the pump from the purge gas inlet. Set the purge gas flow rate 9.2Pa·L/sec (5sccm).

 <b>Caution</b>	<b>Excessive or insufficient purge gas flow may cause deterioration or failure of the pump.</b>
--	---

 <b>Warning</b>	<b>Do not use the pump to exhaust gallium, mercury, their compounds or corrosive gas. It may result in pump failure.</b>
--	--

**6-2. Operation**

Push the start button of ETC76 or send the Start signal to ETC76, and the pump begins starting up. Push the stop button of ETC76 or send the Stop signal to ETC76, and the pump begins shutting down by free-running (without brake). Startup time is about 2.5 minutes, and shutdown time is about 25 minutes. Refer to Section 12 about startup time and shutdown time. Refer to the instructions manual of ETC76.

 <b>Caution</b>	<b>Do not disconnect the connector when operating the pump.</b>
--	---

**6-3. Procedure of start / Stop**

As for procedure of start / stop, refer to following two examples.

 <b>Warning</b>	<b>Vent the inside of the pump to atmosphere when stopping the pump completely. Oil vapor may flow back to whole inside of the pump. If the pump is kept in vacuum. Backflow like this case may cause degrading. Do not make the pressure inside the pump higher than 0.17MPa (0.7kGF/cm<sup>2</sup>g, 10.2psiG). It may cause the pump damage</b>
--	--



a. Example 1 (system with main valve and foreline valve)

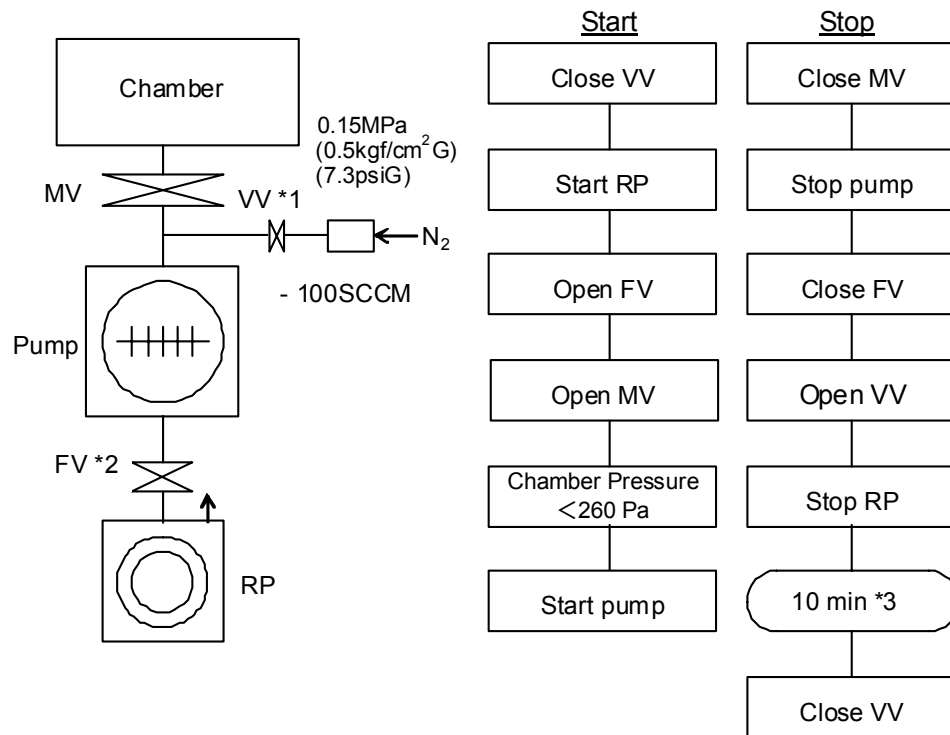

- Pump: EBT70F-20
- RP: Rotary pump
- MV: Main valve
- VV: Vent valve
- FV: Foreline valve

- \*1 Attach a VV between the FV and the pump, according to the system.
- \*2 You can omit the FV if the RP equips a valve of shut-off type.
- \*3 Deceleration time of the rotor

Figure 7 Example 1 of start/stop procedure

**b. Example 2 (system without main valve or foreline valve)**

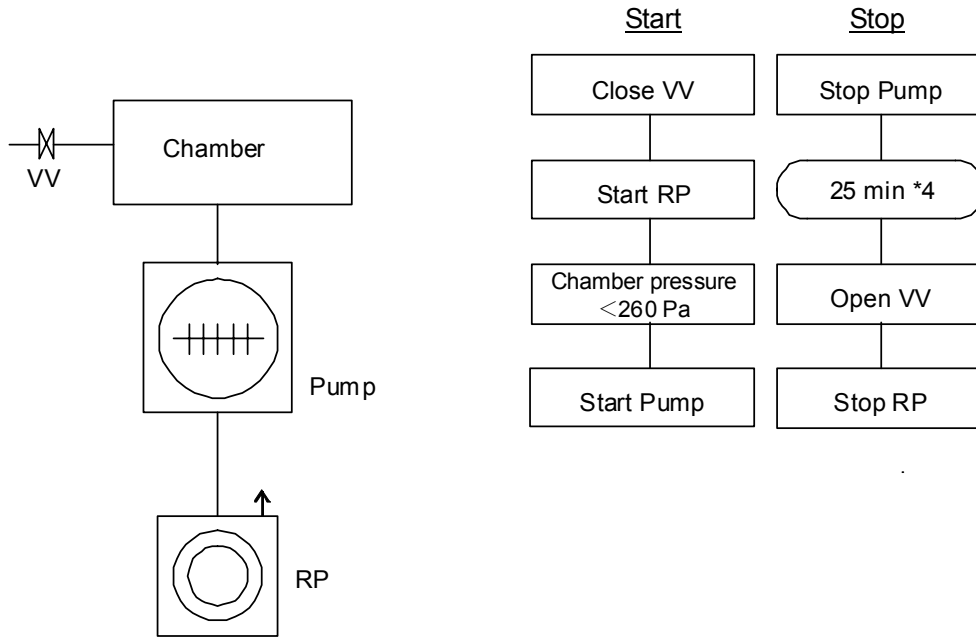

\*4 Deceleration time of the rotor

Figure 8 Example 2 of start/stop procedure

**6-4. Start / Stop during operation**

The pumps can be decelerated while accelerated, or re-accelerated while decelerating. If the rotation speed is 50rps or slower when re-starting, the pump keeps decelerating for 65 seconds after receiving Start signal, and then begins to re-start.

**7. Baking**

Baking the chamber will improve the ultimate pressure. Do not allow the heat from the chamber to overheat the pump.

When baking the chamber, set the temperature of the inlet flange to below 80°C (176°F) or lower.



**8. Maintenance**

**8-1. Vibration**

If the level of pump vibration increases abnormally during normal operation, which you can feel by hand or measured full amplitude of the vibration is 1 μm or more with vibration meter, contact EBARA Corporation.

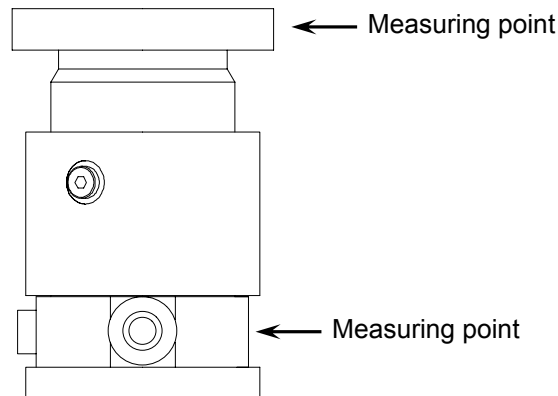

Figure 9 Measuring point of vibration on casing and housing

**8-2. Dust**

Depending on conditions, dust may accumulate inside the pump, continued accumulation of dust may render the pump inoperable. Overhaul the pump periodically, according to the conditions.

**8-3. Reaction product**

Much accumulation of reaction products in the pump may render the pump inoperable, and more serious trouble. Overhaul the pump periodically if the pump has accumulation of reaction products.

 <p>Caution</p>	<p><b>The reaction products will corrode the internal components of the pump, making it impossible to overhaul the pump.</b></p>
--	--

**8-4. Gas handling**

When handling gases, read the MSDS (Material Safety Data Sheet) provided by the gas supplier and take appropriate protective measures to ensure safety.

**8-5. Exchange of bearing**

The lifetime of the bearing varies with conditions. Overhaul the pump periodically to exchange the bearings. Every 20,000 hours with non-reactive gas is recommended. Consult with EBARA Corporation about exchange of the bearings if the pump needs to exhaust a gas with dust.



#### **8-6. Air inrush**

The pump can be restarted easily after an accidental air inrush. Contact EBARA Corporation if you experience any difficulties.

#### **8-7. Caution about operation at low temperature**

It is possible that the pump has failure of delay in acceleration, when operating the pump at low temperature. Because the viscosity of the lubricant rises by low temperature, it requires larger torque to accelerate, and the speed does not reach the rated speed within a specified time. In this case, re-start the pump after resetting the failure.

#### **9. Storage**

For long-term storage of the pump, seal the inlet, purge port, leak port and the outlet with blank flange and so on.

Purge the pump with inert gas such as nitrogen to remove reactive gas from inside of the pump.

When a reactive product is accumulated in the pump, overhaul the pump before storage.

Do not store the pump in the following areas:

- 1) High temperature and/or high humidity
- 2) In strong electric and/or magnetic field
- 3) Near reactive, corrosive and/or toxic gas
- 4) Radiation area
- 5) Under dripping water
- 6) Near strong vibrations
- 7) Dusty area
- 8) Dewfall area
- 9) Sea breeze area

It is possible to get failure caused by bad lubrication when the pump is stored more than 6 months. If the pump has any problem, contact EBARA Corporation.

It is available for operation check of the pump at EBARA Corporation or our service centers. Or, operate the pump every 6 months for lubrication of the bearing.



**10. Overhaul and service recommended**

The meantime of overhaul of the pump varies in applications and natures of gases pumping. Be sure to overhaul the pump before 20,000 hours operation, which is the lifetime of a bearing when the pump evacuates non-reactive gas only. The pump has to be overhauled, even if it does not appear to have any issues when the operation time reaches 20,000 hours. Consult with EBARA Corporation about replacement of the bearings when the pump needs to evacuate corrosive gas, reactive gas or dust.

Contact EBARA Corporation or a service agent contracted with EBARA Corporation when the pump needs overhaul or repair.

Be sure to disclose all the evacuated gases that are harmful and/or reactive and/or flammable, and even non-harmful and non-reactive non-flammable gases before shipping back to EBARA Corporation or service agent. Otherwise, the pump cannot be overhauled or repaired.

Purge inside the pump with non-reactive gas before sending back. Cover the inlet flange, the outlet flange, the vent port and the purge gas inlet firmly to avoid leaking the reactive products from the pump.

Table 7 Volume inside the pump

Pump model	Volume
EBT70FRAB-20 EBT70FRNB-20	0.2 L
EBT70FCAB-20 EBT70FCNB-20	0.3 L

 <b>Warning</b>	<p><b>If you could not help using the pump to exhaust toxic or reactive or flammable gas, purge the pump with inert gas before removing it from the equipment. Wear protective equipment to prevent exposure to the gas.</b></p> <p><b>Be sure to disclose all the exhaust gases that are harmful and/or reactive and/or flammable, and even non-harmful and non-reactive and non-flammable gases before sending back to EBARA Corporation or the service agent. Otherwise, the pump cannot be overhauled or repaired. When transporting the pump, seal the inlet and the outlet.</b></p>
--	---



### 11. Disposal

When the pump is disposed, the customer should follow the instructions by each self-governing community as industrial waste.

	<b>Warning</b>	<b>Dispose the pump after treating the gases and byproducts inside of the pump appropriately.</b>
--	----------------	---

### 12. Specifications

Allowable gas flow rate	EBT70FRAB-20 EBT70FCAB-20	N <sub>2</sub>	37 Pa·L/s (20 sccm)
		Ar	18 Pa·L/s (10 sccm)
	EBT70FRNB-20 EBT70FCNB-20	N <sub>2</sub>	18 Pa·L/s (10 sccm)
		Ar	9.2 Pa·L/s (5 sccm)
Allowable backing pressure <sup>1)</sup>			1200 Pa (9Torr)
Backing pump recommended			≥ 25 L/min
Startup time			2 – 2.5 min (at 10Pa or lower of backing pressure)
Shutdown time			20 – 25 min (without venting)
Vibration (0-peak)			≤ 0.2 μm
Rated rotational speed			90000 min <sup>-1</sup>
Mount position <sup>2)</sup>			Free
Allowable surface temperature of pump			< 50 °C (122 °F) (Casing)
			< 50 °C (122 °F) (Housing)
Allowable ambient temperature			8 – 38 °C (46 – 100 °F)
Allowable humidity			5 – 85 %
Weight	EBT70FRAB-20 EBT70FRNB-20	2.6 kg (6 lb)	
	EBT70FCAB-20 EBT70FCNB-20	4.6 kg (10 lb)	
Refilling grease			No requirement
IP code			IP20 (service area, operating area)
Maximum noise level			60dB(A)

1) Pressure which the pump can operate without gas load.

2) Secure the pump firmly to the equipment.



## Contacting EBARA

### North America – U.S. Headquarters

EBARA TECHNOLOGIES, INC.  
51 Main Avenue  
Sacramento, CA 95838, U.S.A.  
Phone: (916) 920-5451

### Asia

Japan EBARA Corporation, Precision Machinery Group  
EBARA Corporation Fujisawa Plant  
4-2-1 Hon-Fujisawa, Fujisawa 251-8502, Japan  
Phone: 81-466-83-8345  
Fax: 81-466-83-9798

Korea EBARA Precision Machinery Korea, Inc.  
15 FL, Kangnam Bldg.  
321 Seocho-Dong, Seocho-Ku, Seoul, Korea  
Phone: 82-2-581-6901  
Fax: 82-2-581-4211

Taiwan EBARA Precision Machinery Taiwan, Inc.  
Room 1406A Chia Hsin Bldg., No. 96, Sec. 2  
Chung Shan N. RD., Taipei Taiwan  
Phone: 886-2-2560-1166  
Fax: 886-2-2560-1177

Singapore EBARA Engineering Singapore PTE. Ltd.  
No. 67 Tuas Ave 1  
Singapore, 638550  
Phone: 65-862-3536  
Fax: 65-861-0589



**Europe**

United Kingdom EBARA Corporation Scotland Branch  
3 & 4 Adam Square-Brucefield Industrial Estate  
Livingston, G-8West Lothian, EH54 9DE U.K.  
Phone: 44-1509-460232  
Fax: 44-1506-460222

Germany EBARA Germany GmbH  
Donaustrasse 7, D-63452  
Hanau, Germany  
Phone: 49-16181-1876-0  
Fax: 49-16181-1876-40