

Beamstopper (with water cooling) with pneumatic actuator

This manual is valid for the valve ordering number(s):

79036- . E14/24/34/44

79040- . E14/24/34/44

79044- . E14/24/34/44

79046- . E14/24/34/44

The fabrication number is indicated on each product as per the label below (or similar):

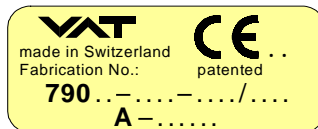

← Fabrication number

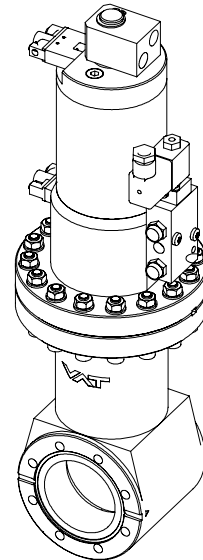

Explanation of symbols:



Read declaration carefully before you start any other action!



Keep body parts and objects away from the valve opening!



Attention!



Hot surfaces; do not touch!



Product is in conformity with EC guidelines, if applicable!



Loaded springs and/or air cushions are potential hazards!



Disconnect electrical power and compressed air lines. Do not touch parts under voltage!



Wear gloves!



Read these «**Installation, Operating & Maintenance Instructions**» and the enclosed «**General Safety Instructions**» carefully before you start any other action!



Installation, Operating & Maintenance Instructions
Series 79, DN 63-200 (I.D. 2½" - 8")

Imprint:

Manufacturer VAT Vakuumventile AG, CH-9469 Haag, Switzerland

Website
www.vatvalve.com

Phone
+41 81 771 61 61

Fax
+41 81 771 48 30

Email
CH@vatvalve.com

Publisher VAT Vakuumventile AG, CH-9469 Haag, Switzerland

Editor VAT Vakuumventile AG, CH-9469 Haag, Switzerland

Print VAT Vakuumventile AG, CH-9469 Haag, Switzerland

Copyright © VAT Vakuumventile AG 2008

No part of these Instructions may be reproduced in any way (photocopies, microfilms or any other reproduction processes) nor may it be manipulated with electronic systems, duplicated or distributed without written permission from VAT. Offenders are liable to pay damages.

The original VAT firmware and updated state of the art versions of the VAT firmware are intended for use with VAT products. The VAT firmware contains a limited, time unlimited user license. The VAT firmware may not be used for purposes other than those intended nor is it permitted to make copies of the VAT firmware. In particular, it is strictly forbidden to give copies of the VAT firmware to other people.

The use of trade names, brand names, trademarks, etc. in these Instructions does not entitle third parties to consider these names to be unprotected and to use them freely. This is in accordance with the meaning of the laws and acts covering brand names and trademarks.



Contents:

1	Use of product	4
1.1	Technical data	4
2	Installation	4
2.1	Unpacking	4
2.2	Installation into the system	4
2.3	Connections	5
2.3.1	Compressed air connection	5
2.3.2	Electrical connection	6
2.3.3	Cooling water connection	7
3	Operation	7
3.1	Normal operation	7
3.2	Operation under increased temperature	8
3.3	Bake out	8
3.4	Behavior in case of compressed air pressure drop	8
3.5	Behavior in case of power failure	8
4	Trouble shooting	9
5	Maintenance & repairs	9
6	Drawing	10
7	Spare parts	11
8	Warranty	12



1 Use of product

Use product for clean and dry indoor vacuum applications under the conditions indicated in chapter «Technical data» only!
Other applications are only allowed with the written permission of VAT.

1.1 Technical data

Pressure range	extreme UHV to 1 bar (abs)
Admissible temperature:	
- Body	≤ 250°C (beam stopper open or closed)
- Pneumatic actuator	≤ 80°C
- Position indicator	≤ 80°C (option: 200°C)
- Solenoid	≤ 80°C
Absorber (with watercooling)	
- max. beam load Ø < 60mm	5 kW
- max. beam load Ø > 60mm	6 kW
- max. density	25 W/mm ²
Mounting position	any
Position indicator:	
- Contact rating	≤ 50 V AC / DC 1.2A (80°C version) ≤ 50 V AC / DC 1A (200°C version)
Solenoid	see tag on solenoid

Further data according to product data sheet.

2 Installation

2.1 Unpacking



Be carefull during opening the boxes and nylon bag, do not contaminate the valve.
Pay attention that valve and flanges are not damaged when the valve is lifted out of the box and handled afterwards.

2.2 Installation into the system

Remove the flanges only prior to the assembly into the vacuum system!

The valve must not support other components and has to be protected from forces of the system (e.g. by bellows section).

2.3 Connections

2.3.1 Compressed air connection



Compressed air may only be connected if

- beam stopper is installed into the vacuum system
- moving parts cannot be touched

Connection: internal thread R 1/8" (1/8" NPT for USA)

Connection for compressed air supply: ⊙

Compressed air pressure (min. - max. overpressure): 4 - 7 bar / 55 - 100 psig

Use only clean, dry or slightly oiled air!

Wiring diagrams:

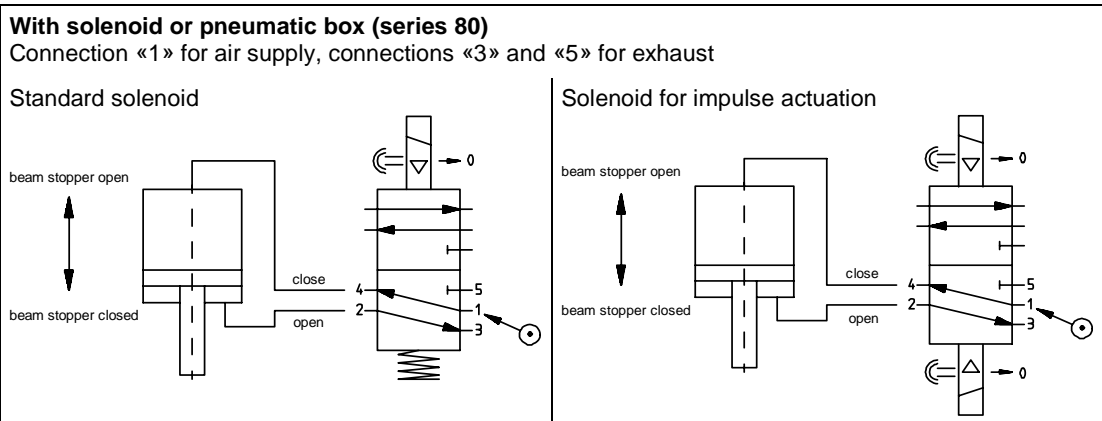
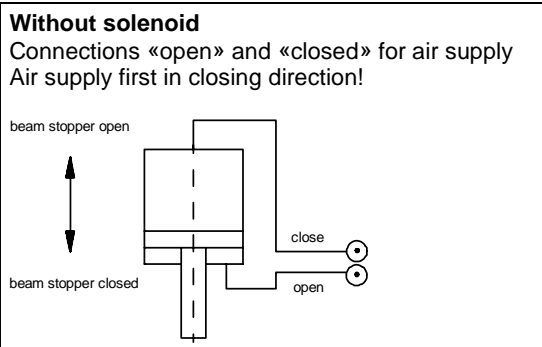

2.3.2 Electrical connection



Do not touch electrical parts under voltage!



Connect electrical power only if
 - beam stopper is installed into the vacuum system
 - moving parts cannot be touched

Verify that control voltage matches voltage stated on the solenoid!
 Socket for solenoid is supplied with the beam stopper.

Wiring diagrams:

Solenoids

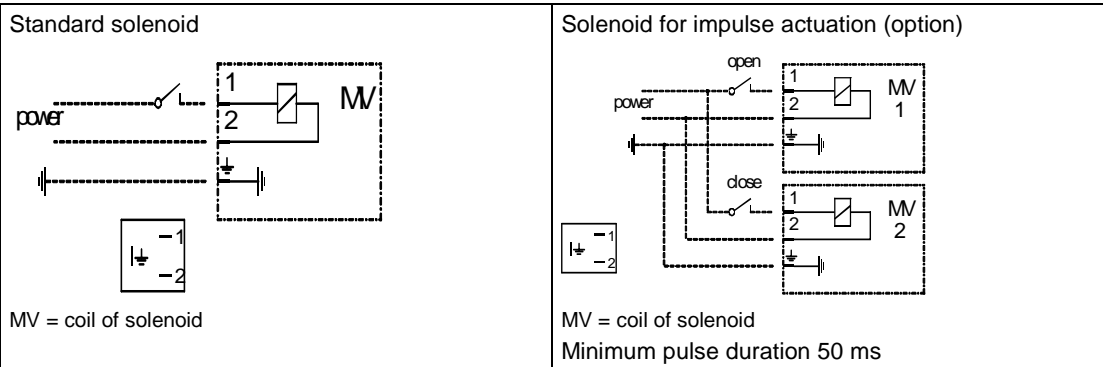

Position indicator

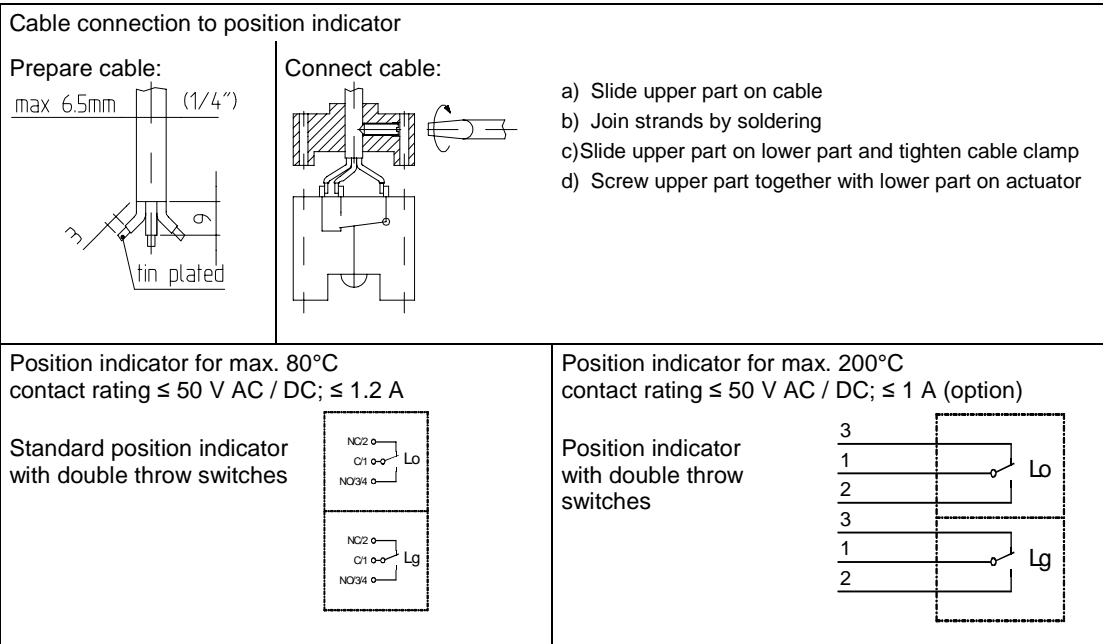

2.3.3 Cooling water connection



Cooling water may only be connected if
- beam stopper is installed into the vacuum system
Connection: internal thread R ¼" (¼" NPT for USA)

- min. quantity of cooling water: 15 l / min
- max. water temperature (supply): 15°C
- max. water pressure: 8 bar / 110 psig

3 Operation

3.1 Normal operation

Opening of closed beam stopper

- without solenoid:
 - before beam stopper is opened — supply air pressure in closing direction
 - air supply to connection «open»
 - air release through connection «closed»
- with standard solenoid:
 - supply specified control voltage to the coil
- with impulse solenoid:
 - supply an impulse of specified control voltage to the coil for opening (pulse duration min. 50 ms)

Closing of open beam stopper

- without solenoid:
 - before beam stopper is closed — supply air pressure in opening direction
 - air supply to connection «close»
 - air release through connection «open»
- with standard solenoid:
 - release control voltage
- with impulse solenoid:
 - supply an impulse of specified control voltage to the coil for closing (pulse duration min. 50 ms)

3.2 Operation under increased temperature

See «1.1 Technical data»

3.3 Bake out

Body: ≤ 250°C in open and closed position
 Actuator: ≤ 80°C
 Position indicator: ≤ 80°C (option: 200°C)
 Solenoid: ≤ 80°C
 Heating and cooling rate: 80°C/h

3.4 Behavior in case of compressed air pressure drop

Beam stopper closed: beam stopper position is undefined
 Beam stopper open: beam stopper position is undefined

3.5 Behavior in case of power failure

Standard solenoid: beam stopper closes
 Solenoid for impulse actuation (option): beam stopper position does not change, a started movement will be completed

Emergency operation at power failure

The solenoids have an emergency operation (slotted screw) to operate the beam stopper in case of a power failure (with compressed air available)

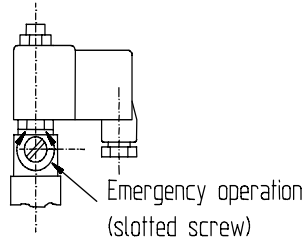
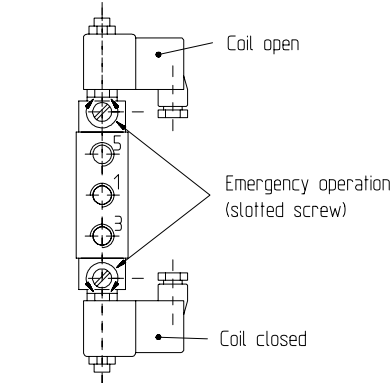
<p>Standard solenoid</p> <p>To <u>close</u> the beam stopper: Turn the slotted screw counter-clockwise to its stop</p> <p>To <u>open</u> the beam stopper: Turn the slotted screw clockwise to its stop</p> <p>For remote operation make sure that the slotted screw is turned counter-clockwise to its stop.</p>	 <p>Emergency operation (slotted screw)</p>
<p>Solenoid for impulse actuation</p> <p>To <u>close</u> the beam stopper: Turn the slotted screw (coil «closed») counter-clockwise to its stop. If the valve is closed, turn the screw back to its original position.</p> <p>To <u>open</u> the beam stopper: Turn the slotted screw (coil «open») counter-clockwise to its stop. If the beam stopper is open, turn the screw back to its original position.</p> <p>For remote operation make sure that both slotted screws are turned clockwise to their stop (original position).</p>	 <p>Coil open</p> <p>Emergency operation (slotted screw)</p> <p>Coil closed</p>



4 Trouble shooting

Failure	Check	Action
Mechanism does not move	Compressed air pressure available?	Check air pressure
	Power available?	Check voltage

If you need any further information, please contact one of our service centers. You can find the addresses on our website: <http://www.vat.ch>

5 Maintenance & repairs

Under clean operating conditions, the valve does not require any maintenance during the specified cycle life. Contamination from the process may influence the function and requires more frequent maintenance.

Before carrying out any maintenance or repairs, please contact VAT. It has to be individually decided whether the maintenance/repair can be performed by the customer or has to be carried out by VAT. The fabrication number on the valve

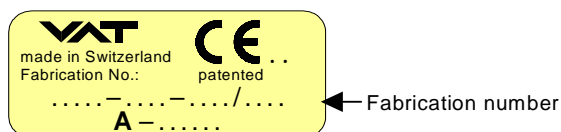

has always to be specified.

All supplies (e. g. compressed air, electrical power) must be disconnected for removal/installation of the valve from/into the system and for maintenance work.



Even with disconnected supply, loaded springs and/or air cushions in cylinders can be potential hazards.



Keep fingers and objects away from the valve opening!

Products returned to VAT must be free of harmful substances such as e.g. toxic, caustic or microbiological ones. If products are radioactively contaminated, fill in the VAT form «Contamination and Radiation Report» and send it with the product. The form is available at VAT. The maximum values indicated in the form must not be exceeded.

6 Drawing

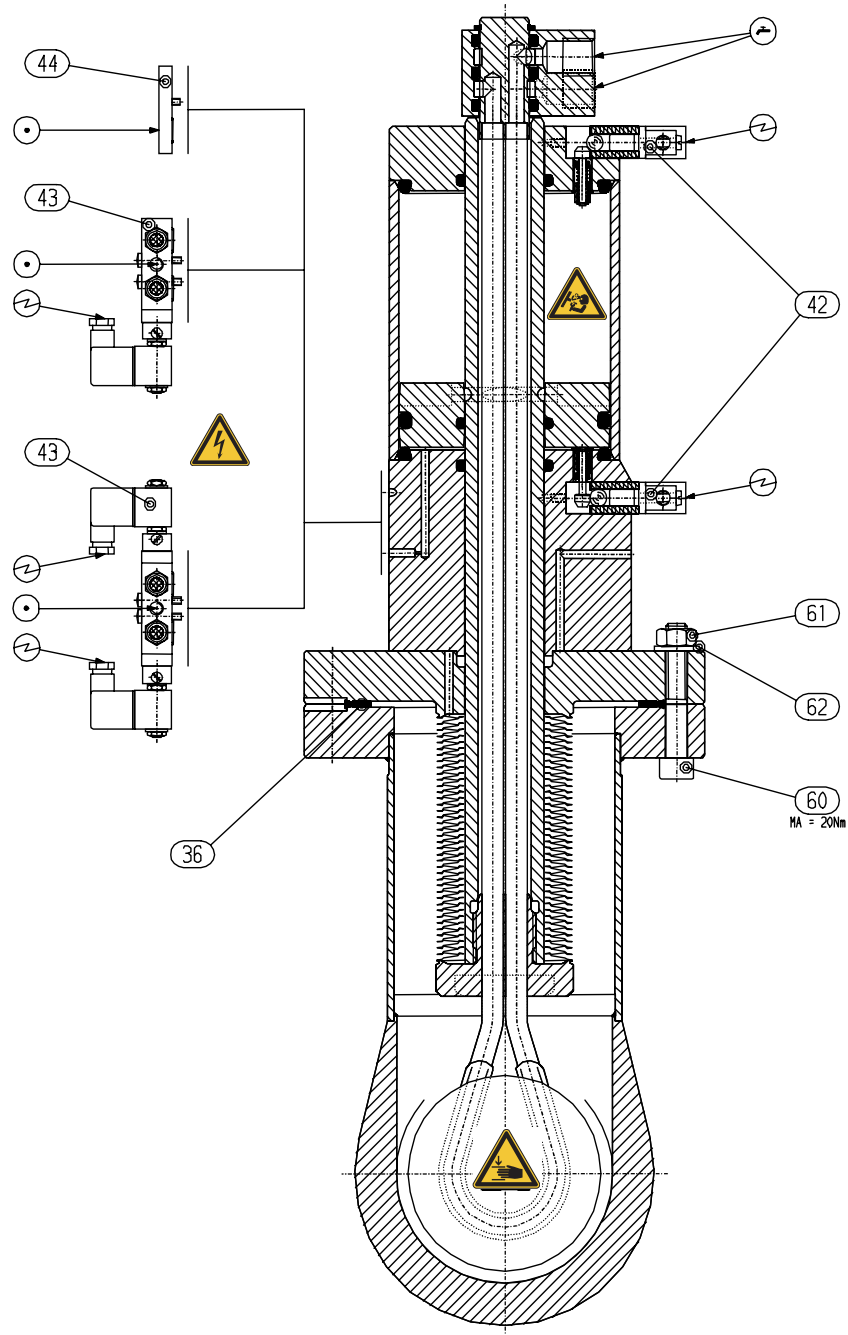

7 Spare parts



Please specify the **fabrication number of the valve** (see yellow label on valve) when ordering spare parts. This is to ensure that the appropriate spare parts are supplied.

The item numbers refer to the drawing on page 10.

	Description	Part / Ordering No.			
		DN 63	DN 100	DN 160	DN 200
60	Treated hexagon socket head cap screw	(16x)224845	(20x)228783	(24x)228783	(32x)228783
61	Hexagon nut	(16x)N-6053-412	(20x)N-6053-412	(24x)N-6053-412	(32x)N-6053-412
62	Washer	(16x)N-6131-414	(20x)N-6131-414	(24x)N-6131-414	(32x)N-6131-414
36	Seal	(1x)33040-CKDF	(1x)33044-CKDF	(1x)33046-CKDF	(1x)33048-CKDF
	Pneumatic seal kit, consisting of all elastomer seals inside the pneumatic actuator: 80°C (standard) 200°C (option) actuator for 10 ⁶ Gy (option)	89260-R1 - -	89260-R1 - -	89260-R1 - -	89260-R1 - -

Air connection kit (solenoid on customer's site)

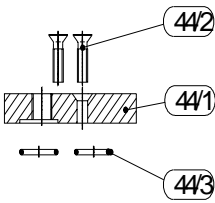
	Item	Description	Version	Qty.	Part No.
		44	Connection kit	standard	1
			actuator for 10 ⁶ Gy	1	86069-R1
	44/1	Plate		1	81428-01
	44/2	Screw		2	N-6013-463
	44/3	O-ring	standard	2	N-7100-016
			actuator for 10 ⁶ Gy	2	N-7115-016

Solenoid kit (5/2-way standard)

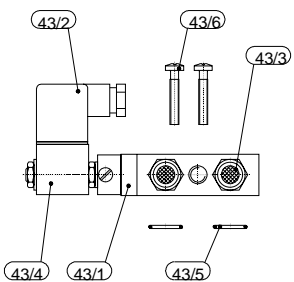
	Item	Description	Qty.	Part No.
		43	Solenoid kit	1
	43/1	Solenoid	1	N-7501-502
	43/2	Socket	1	N-8501-300
	43/3	Sound absorber	2	N-7705-001
	43/4	Coil**	1	N-7510-2**
	43/5	O-ring	2	N-7100-016
	43/6	Screw	2	N-6024-562

Solenoid kit (5/2-way impulse actuation)

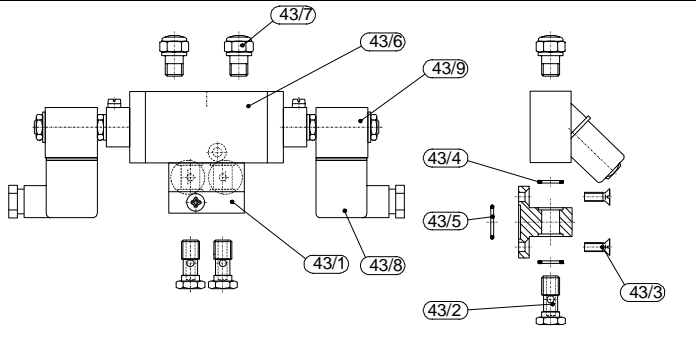
	Item	Description	Qty.	Part No.
	43	Solenoid kit	1	
	43/1	Connection plate	1	
	43/2	Hollow screw	2	N-5060-010
	43/3	Screw	2	N-6013-462
	43/4	Gasket	4	N-7016-010
	43/5	O-ring	2	N-7100-016
	43/6	Solenoid	1	N-7502-504
	43/7	Sound absorber	2	N-7705-001
	43/8	Socket	2	N-8501-300
43/9	Coil**	2	N-7510-2**	

** Specify voltage: (e.g. N-7510-2-**220V 50Hz**)

Position indicator 80°C + 200°C

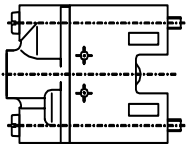
	Item	Description	Version	Qty.	Part No.
	42	BS position indicator	double throw switches	2	78855-R1 (80°C)
	42	BS position indicator	double throw switches	2	88193-R1 (200°C)

8 Warranty

Each product sold by VAT Vakuumentile AG (VAT) is warranted to be free from the manufacturing defects that adversely affect the normal functioning thereof during the warranty period stated in VAT's «Terms of Sale» immediately following delivery thereof by VAT, provided that the same is properly operated under conditions of normal use and that regular, periodic maintenance and service is performed or replacements made, in accordance with the instructions provided by VAT. The foregoing warranty shall not apply to any product or component that has been repaired or altered by anyone other than an authorized VAT representative or that has been subject to improper installation or abuse, misuse, negligence or accident. VAT shall not be liable for any damage, loss, or expense, whether consequential, special, incidental, direct or otherwise, caused by, arising out of or connected with the manufacture, delivery (including any delay in or failure to deliver), packaging, storage or use of any product sold or delivered by VAT shall fail to conform to the foregoing warranty or to the description thereof contained herein, the purchaser thereof, as its exclusive remedy, shall upon prompt notice to VAT of any such defect or failure and upon the return of the product, part or component in question to VAT at its factory, with transportation charges prepaid, and upon VAT's inspection confirming the existence of any defect inconsistent with said warranty or any such failure, be entitled to have such defect or failure cured at VAT's factory and at no charge therefor, by replacement or repair of said product, as VAT may elect. VAT MAKES NO WARRANTY OR REPRESENTATION OF ANY KIND, EXPRESS OR IMPLIED, (INCLUDING NO WARRANTY OR MERCHANTABILITY), EXCEPT FOR THE FOREGOING WARRANTY AND THE WARRANTY THAT EACH PRODUCT SHALL CONFORM TO THE DESCRIPTION THEREOF CONTAINED HEREIN, and no warranty shall be implied by law.

Furthermore, the «Terms of sale» at the back of the price list are applicable.