

This drawing is the property of VAT.
 Without the written consent of VAT, it must
 not be copied or distributed to a third person

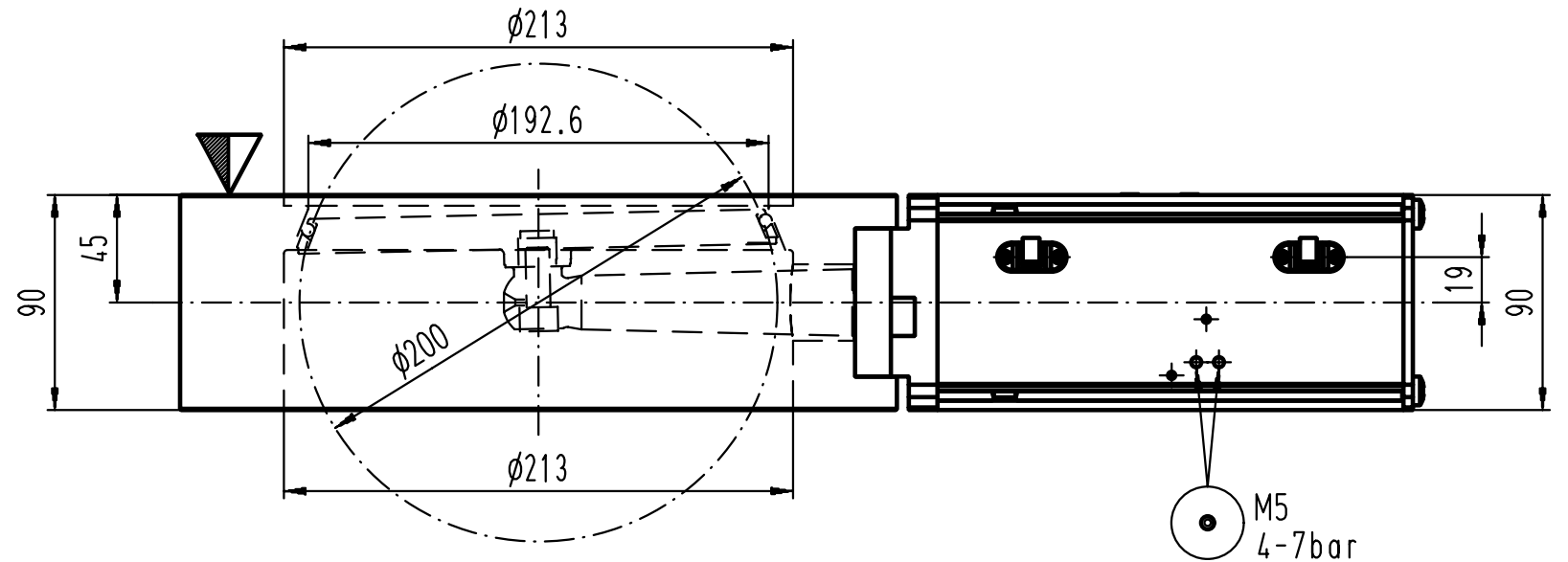

SECTION A-A:

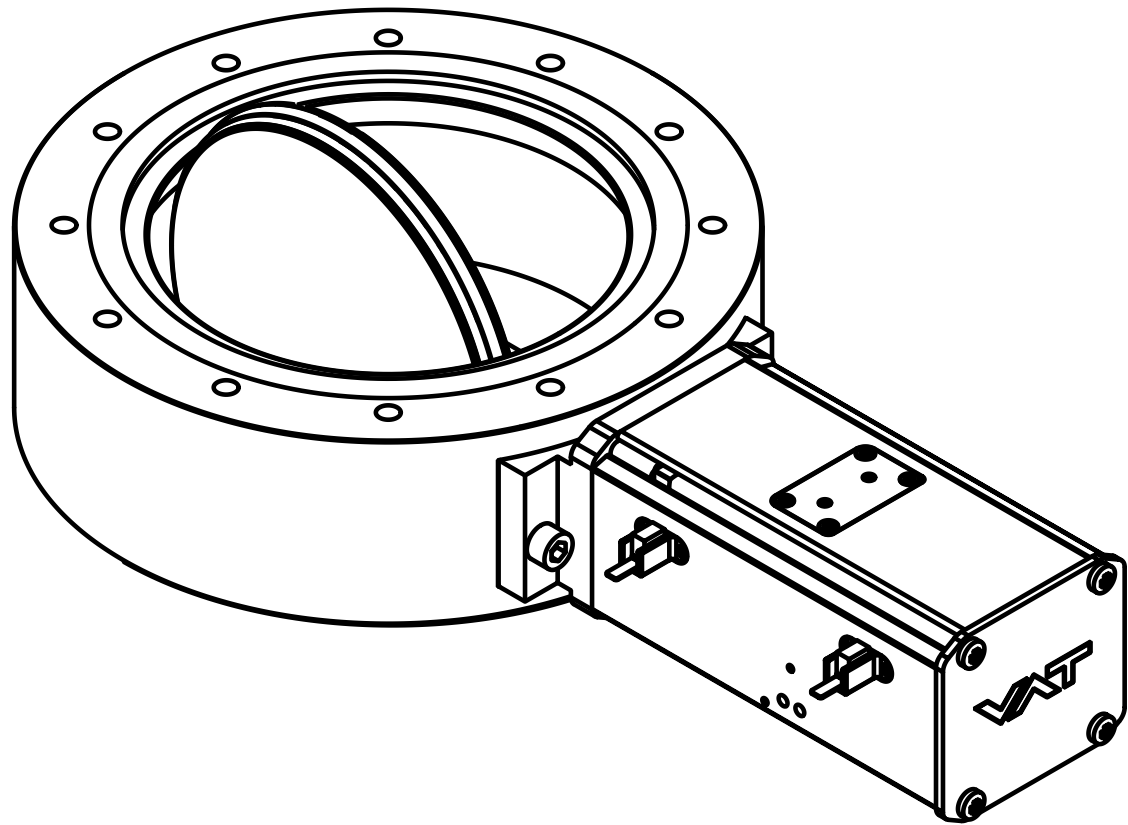
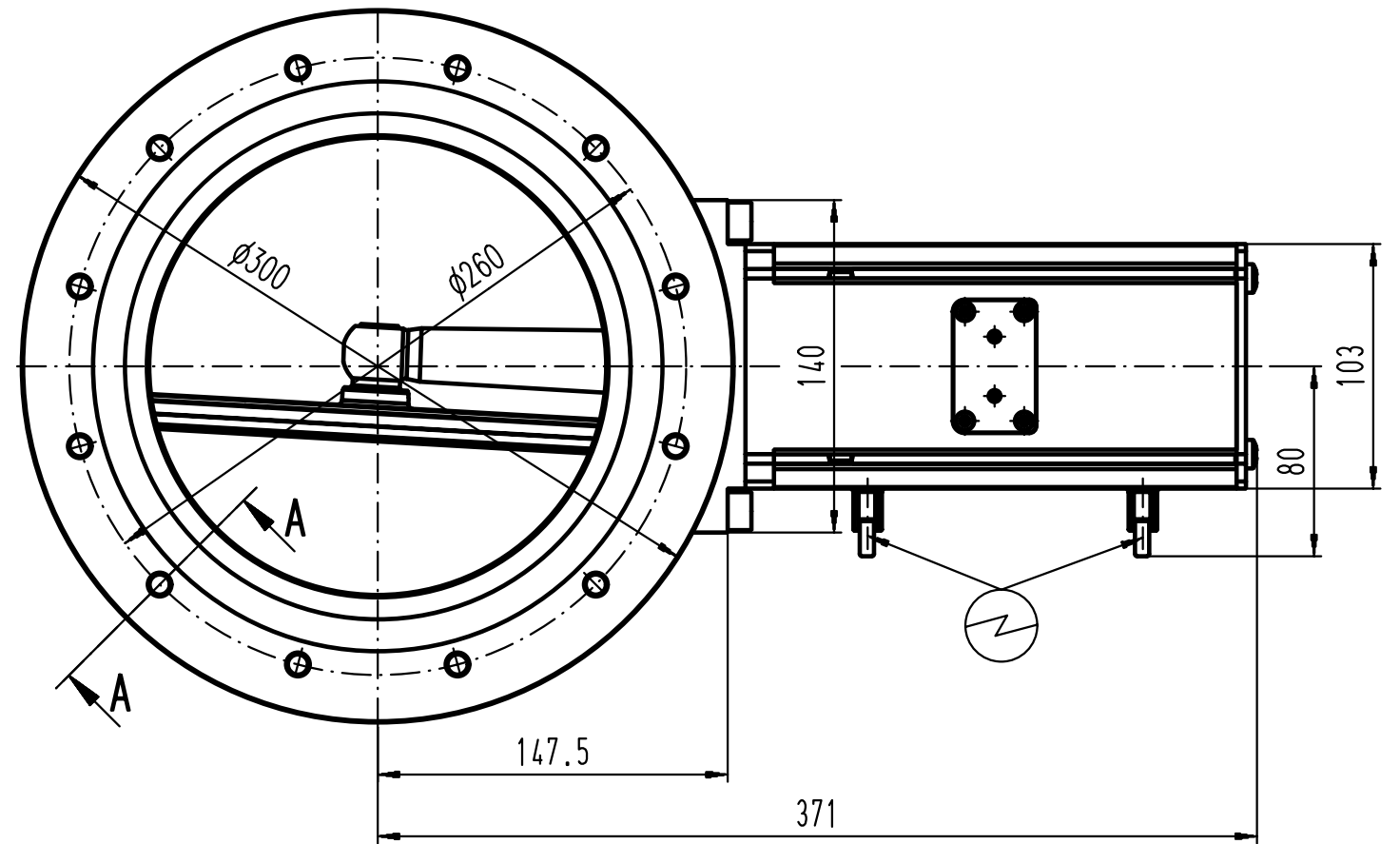
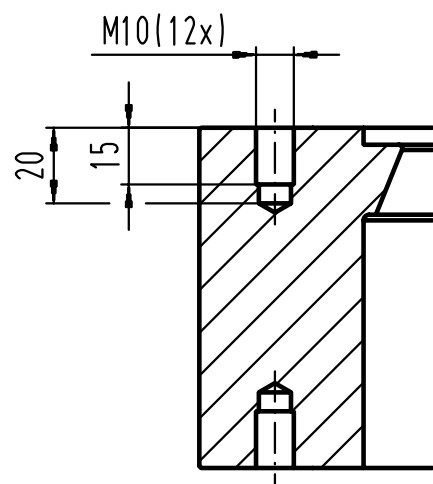

Revision	
Code	
Date	
Name	

- ▼ Seat side
- ⊙ Comp. air connection
- ⊕ Electrical connection
- ⊖ Leak detection port
- ⊗ Mech. pos. indication
- ⊘ Position indicator
- ⊙* Required for dismantling
- ⊙ Emergency actuation
- ⊙ For attachment
- ⊙ Bake-out area
- ⊙ Differential pumping port

Vatterfly Valve
 pneumatic actuator



VAT Vakuumventile AG
 CH-9469 Haag, Switzerland
 Tel ++41 81 7716161 Fax ++41 81 7714830

Date: 22.11.02
 Name: KIM

Series	20.3	Ordering No.	20346-PA24
Projection E		DN	200
		Flange	ISO-F
Dimensional Drawing			234549
		Rev.	