



VAT Vakuumventile AG
CH-9469 Haag, Schweiz

Product data sheet

Pendulum valve, Series 162, DN 200 (ID 8")
Ordering No. 16246-PA41

Description

Flange	ISO-F 200
Actuator	– pneumatic, single acting, with closing spring (NC) – with solenoid valve – with position indicator
Feedthrough	Rotary feedthrough

Technical data

Leak rate	– Valve body – Valve seat	$< 1 \cdot 10^{-9}$ mbar ls ⁻¹ $< 1 \cdot 10^{-9}$ mbar ls ⁻¹
Pressure range		$1 \cdot 10^{-8}$ mbar to 1.2 bar (abs)
Differential pressure on the gate		≤ 1.2 bar
Differential pressure at opening		≤ 10 mbar
Conductance (molecular flow)		11 000 ls ⁻¹
Cycles until first service		200 000 (unheated and under clean conditions)
Temperature (Maximum values: depending on operating conditions and sealing materials)	– Valve body – Actuator – Solenoid valve – Position indicator	≤ 120 °C ≤ 80 °C ≤ 50 °C ≤ 80 °C
Heating and cooling rate		≤ 30 °C h ⁻¹
Material	– Valve body, gate, sealing ring – Feedthrough	EN AW-5083 (3.3547), EN AW-6082 (3.2315) AISI 303 (1.4305), AISI 304 (1.4301)
Seal	– Bonnet – Gate, dynamic – Feedthrough	FKM (Viton®) FKM (Viton®) FKM (Viton®)
Mounting position		any
Volume of pneumatic actuator		0.30 l / 0.010 ft ³
Compressed air min. – max. overpressure		5 – 7 bar / 73 – 102 psi
Compressed air connection		G1/8" (ISO / NPT for USA)

Created by: MAEM	Release date: 2013-01-29	1 of 2
Modified by:	Release date:	600337EA



VAT Vakuumventile AG
CH-9469 Haag, Schweiz

Product data sheet

Pendulum valve, Series 162, DN 200 (ID 8")
Ordering No. 16246-PA41

Actuation time	- closing	4 s
	- opening	4 s
Weight		23 kg / 50.7 lbs
Behavior in case of compressed air pressure drop	- Valve closed	valve remains closed
	- Valve open	valve closes
Behavior in case of power failure	- Valve closed	valve remains closed
	- Valve open	valve closes

Electrical connections

Solenoid valve

Type	4/2 way
Voltage	Defined by order

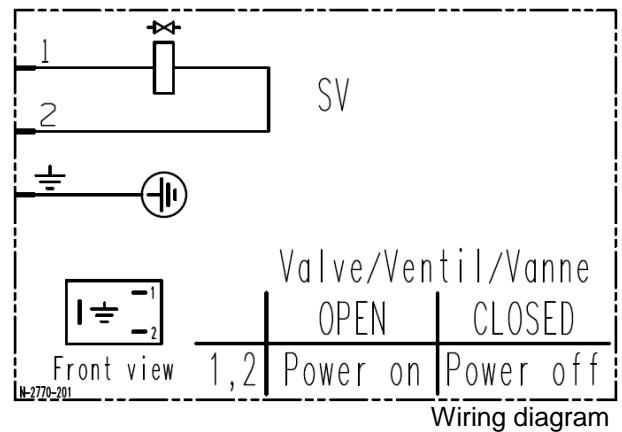

Position indicator

Type	Micro switch
Voltage	≤ 50 V AC
Current max.	≤ 1.2 A

